

CARDIAC & VASCULAR INSTRUMENTS

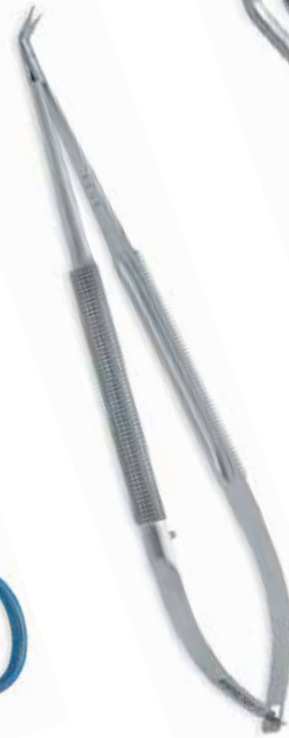

International Instruments
Designers & Manufacturers of Surgical Instruments



JJ International Instruments

Designers & Manufacturers of Surgical Instruments

US FDA, CE & ISO REGD.

ABOUT US

JJ International Instruments - A leader in designing and manufacturing of high quality stainless steel surgical instruments in India. With a vast experience of 46 years in the industry, JJ provides unmatched service and unbeaten quality to the worldwide market. Corporate office and manufacturing unit with state of art facilities is located in south Indian state, Kerala - The renowned 'God's Own Country'.

CONTINUES SUCCESS...

JJ became world wide since exhibited in AAOS 2013 with tremendous response from both domestic and international surgeons. JJ now participates many tradeshow in USA and more than 30 tradeshow all over India yearly. JJ is the only one company now in India who has approved by US FDA.

*"International
Quality
@
Indian Price"*

CE Reg No. DCS/943962
ISO Reg No. QACS-A-0623
US FDA Reg No. 3010077069

INDIA

Corporate Off. & Factory:
Kinra Park P.O.
Thrissur Dist., Kerala
India - 680 309
+91 480 2734999

JJ design & manufacture complete Surgical Instruments for - General Orthopaedic, Spine, Hand & Micro Surgery, Gynec & Obstetrics, Uro, E.N.T, Neuro, Thoracic & Cardiovascular, Plastic, General surgery.

Features and Benefits

- Genuine 'JJ' Brand
- Custom made Instruments
- Made out of German Stainless Steel- SS410& SS 420
- Follows International Passivation standard - ASTM 967
- International hardness of product - 45 HRC & 50 HRC
- Universal Specifications & Quality
- 5 years replacement warranty against manufacturing defect
- Absolute Competitive price
- JJ welcomes innovative ideas and designs
- Gift packs on attractive terms

JJ's repairing & refurbishing program:

- Repairing & refurbishing of surgical instruments of any brand
- Reduce purchase budget drastically
- Annual Maintenance Contract (AMC)
- Round the clock service center
- Replace damaged instrument with new until rectification

JJ's Mobile Trade Expo

- Introducing mobile sales and service all over India
- Specially designed Instruments on display
- Easy to select, exchange and experience
- Get technical advice from the experts
- Contact us for mobile trade expo schedules

www.myjjonline.com

sales@myjjonline.com, myjjonline@yahoo.com

UAE

Sales Office:
Suite E-74G-35
Hamriyah Free Zone
Sharjah, UAE
+971 50 7571358

OMAN

Service & Sales Office:
Suite 122, Bldg 579
Masabala Industrial Area
Muscat, Oman
+968 9965 3791

USA

Sales Office:
1000 Centre Greenway
Suite 209, Cary
North Carolina 27513
+1 919 467 5278



VASCULAR CATALOGUE INDEX

NEEDLE HOLDERS

	Page No.
Castroviejo Needle Holders	1
Jacobson Needle Holders	2 & 3
Barraquer Micro Needle Holders	4
Bayonet Micro Needle Holders	5
Tungsten Carbide Needle Holders	6, 7, 8, 9 & 10

FORCEPS

DeBakey Tissue Forceps	11
Dissecting Forceps	12
Gerald Tissue Forceps	13 & 14
Micro Platform Forceps	15
Micro Ring Tip Forceps	16
Micro DeBakey Forceps	17
Bayonet Micro Forceps	18
Bipolar Forceps	19, 20 & 21

SCISSORS

Bipolar Scissors	22
Iris & Strabismus Scissors	23
Tenotomy Scissors	24
Metzenbaum Scissors	25
Mayo Scissors	26
Diethrich Vascular Scissors	27 & 28
Bayonet Micro Scissors	29
Micro Coronary Scissors	30, 31 & 32
Micro Flat & Round Bodied Scissors	33 & 34

RETRACTORS

Rib Spreaders & Approximators	35 to 40
Abdominal Ring Retractor Set	41 & 42
Vessel Probes & Hooks	43
Mini Retractors & Hooks	44
Hand Held Retractors	45 & 46
Self Retaining Retractors	47
Rib Raspatories	48
Rib & Bone Cutters	49
Wire Cutters	50
Micro Dissectors	51 & 52

BULLDOG CLAMPS

	Page No.
Acland Micro Vessel Clamps	53 to 54
Diethrich Bulldog Clamps	55
DeBakey Diethrich Bulldog Clamps	56
Titanium Glover Bulldog Clamps	57
Glover Bulldog Clamps	58
Carotid Bulldog Clamps	59 & 60
DeBakey Bulldog Clamps	61
Titanium DeBakey Bulldog Clamps	62

VASCULAR CLAMPS

Titanium Paediatric DeBakey Clamps	63
DeBakey Castaneda Paediatric Clamps	64
DeBakey Ring Handled Clamps	65
Aortic Clamps	66 & 67
Patent Ductus Clamps	68
Peripheral Clamps	69 & 70
Multi Purpose Clamps	71 & 72
DeBakey Occlusion Clamps	73
DeBakey Anastomosis Clamps	74 & 75
DeBakey Ligature Clamps	76
Cooley Clamps	77
Carotid Clamps	78

VARIOUS INSTRUMENTS

Suction Tubes & Cannula	79 & 80
Perfusion Cannula	81
Vessel Dilators & Probes	82
Sterilisation Containers	83
Miscellaneous	84

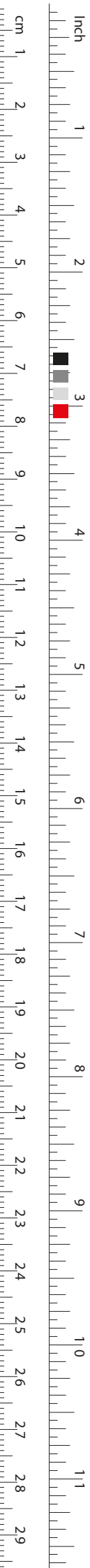

MICRO NEEDLE HOLDERS

Castroviejo Micro Needle Holder

- Flat Handled
- Tungsten Carbide Jaws
- Straight 1.2mm Jaws



With Lock	Serrated Jaws	Smooth Jaws	Without Lock	Serrated Jaws	Smooth Jaws
13cm/5"	CV1003-13	CV1003-13S	13cm/5"	CV1103-13	CV1103-13S
18cm/7"	CV1003-18	CV1003-18S	18cm/7"	CV1103-18	CV1103-18S
20cm/8"	CV1003-20	CV1003-20S	20cm/8"	CV1103-20	CV1103-20S
21cm/8 1/4"	CV1003-21	CV1003-21S	21cm/8 1/4"	CV1103-21	CV1103-21S

Castroviejo Micro Needle Holder

- Flat Handled
- Diamond Dusted Jaws
- Straight 1.2mm Jaws



With Lock		Without Lock	
14cm/5 1/2"	CV1001-14	14cm/5 1/2"	CV1101-14
18cm/7"	CV1001-18	18cm/7"	CV1101-18
21cm/8 1/4"	CV1001-21	21cm/8 1/4"	CV1101-21

Titanium Castroviejo Micro Needle Holder

- Flat Handled
- Diamond Dusted Jaws
- Straight 1.2mm Jaws



With Lock		Without Lock	
15cm/6"	CV1001-15T	15cm/6"	CV1101-15T
18cm/7"	CV1001-18T	18cm/7"	CV1101-18T
21cm/8 1/4"	CV1001-21T	21cm/8 1/4"	CV1101-21T
24cm/9 1/2"	CV1001-24T	24cm/9 1/2"	CV1101-24T

MICRO NEEDLE HOLDERS

Reill Micro Needle Holder

- Round Bodied
- Diamond Dusted Jaws
- Delicate 1mm Jaws



With Lock	Straight	Curved	Without Lock	Straight	Curved
14.5cm/5 3/4"	MV1005-14	MV1006-14	14.5cm/5 3/4"	MV1105-14	MV1106-14

Jacobson Micro Needle Holder

- Round Bodied
- Diamond Dusted Jaws
- Straight Delicate 1mm Jaws



With Lock		Without Lock	
18cm/7"	MV1005-18	18cm/7"	MV1105-18
21cm/8 1/4"	MV1005-21	21cm/8 1/4"	MV1105-21
23cm/9"	MV1005-23	23cm/9"	MV1105-23

Titanium Jacobson Micro Needle Holder

- Round Bodied
- Diamond Dusted Jaws
- Straight



With Lock	Standard 1.2mm Jaws	Delicate 1mm Jaws	Without Lock	Standard 1.2mm Jaws	Delicate 1mm Jaws
15cm/6"	CV1005-15T	CV1005-15FT	15cm/6"	CV1105-15T	CV1105-15FT
18cm/7"	CV1005-18T	CV1005-18FT	18cm/7"	CV1105-18T	CV1105-18FT
21cm/8 1/4"	CV1005-21T	CV1005-21FT	21cm/8 1/4"	CV1105-21T	CV1105-21FT
23cm/9"	CV1005-23T	CV1005-23FT	23cm/9"	CV1105-23T	CV1105-23FT

MICRO NEEDLE HOLDERS

Jacobson Micro Needle Holder

- Round Bodied
- Tungsten Carbide Jaws
- 1.2mm Jaws



With Lock	Straight	Curved	Without Lock	Straight	Curved
15cm/6"	MV1007-15	MV1008-15	15cm/6"	MV1107-15	MV1108-15
18cm/7"	MV1007-18	MV1008-18	18cm/7"	MV1107-18	MV1108-18
21cm/8 1/4"	MV1007-21	MV1008-21	21cm/8 1/4"	MV1107-21	MV1108-21
23cm/9"	MV1007-23	MV1008-23	23cm/9"	MV1107-23	MV1108-23

Jacobson 'Heavy Style' Needle Holder

- Round Bodied
- Diamond Dusted Jaws
- For Larger Needles - 3/0 size
- Straight Jaws



With Lock		Without Lock	
18cm/7"	MV1017-18	18cm/7"	MV1117-18
23cm/9"	MV1017-23	23cm/9"	MV1117-23
25cm/10"	MV1017-25	25cm/10"	MV1117-25

Titanium Jacobson 'Heavy Style' Needle Holder

- Round Bodied
- Diamond Dusted Jaws
- For Larger Needles - 3/0 size
- Straight Jaws



With Lock		Without Lock	
18cm/7"	MV1017-18T	18cm/7"	MV1117-18T
23cm/9"	MV1017-23T	23cm/9"	MV1117-23T
25cm/10"	MV1017-25T	25cm/10"	MV1117-25T

Barraquer Micro Needle Holder

- Round Bodied
- 0.4mm Jaws



Without Lock	Straight	Curved
13cm/5"	BS-13-8	B-13-8
15cm/6"	BS-15-8	B-15-8
18cm/7"	BS-18-8	B-18-8

Castroviejo Micro Needle Holder

- Flat Handed
- 0.4mm Jaws



Without Lock	Curved
14cm/5 1/2"	C-14
18cm/7"	C-18

Double Action Micro Needle Holder

- Round Bodied
- 0.4mm Jaws



Without Lock	Curved
15cm/6"	NH-15 RM-8
18cm/7"	NH-18 RM-8

Yasargil Bayonet Micro Needle Holder

- Flat Handled
- Delicate 1mm Jaws



With Lock	Straight	Curved	Without Lock	Straight	Curved
23cm/9"	CV1012-23	CV1013-23	23cm/9"	CV1112-23	CV1113-23

Bayonet Micro Needle Holder

- Round Bodied
- Delicate 1mm Jaws



With Lock	Straight	Curved	Without Lock	Straight	Curved
21cm/8 1/4"	MV1010-21	MV1011-21	21cm/8 1/4"	MV1110-21	MV1111-21
23cm/9"	MV1010-23	MV1011-23	23cm/9"	MV1110-23	MV1111-23

RING HANDLED NEEDLE HOLDERS

Derf Needle Holder
12cm/4³/₄" TC



703DE12

Smooth



705DE12



Halsey Needle Holder
13cm/5" TC



706DE13

Smooth



704DE13



Nieverts Needle Holder (offset ring)
13cm/5" TC



783DE13









RING HANDLED NEEDLE HOLDERS

Mayo Hegar Needle Holder

- Tungsten Carbide Inserts
- Heavy Jaws







						
14cm/5 1/2"	16cm/6 1/4"	18cm/7"	20cm/8"	23cm/9"	26cm/10 1/4"	30cm/12"
707DE14	707DE16	707DE18	707DE20	707DE23	707DE26	707DE30

Crile Wood Needle Holder

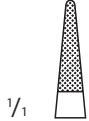
- Tungsten Carbide Inserts
- Fine Jaws



				
15cm/6"	18cm/7"	20cm/8"	23cm/9"	26cm/10 1/4"
712DE15	734DE18	734DE20	734DE23	734DE26

RING HANDLED NEEDLE HOLDERS

DeBakey Needle Holder

- Tungsten Carbide Inserts
- Fine Jaws

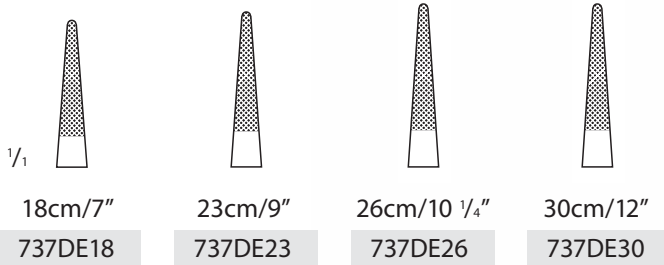

Micro Vascular Needle Holder

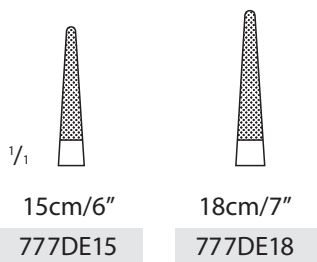

- Tungsten Carbide Inserts
- Slim Delicate Pattern



Micro Ryder Needle Holder

- Tungsten Carbide Inserts

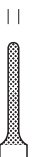
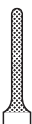
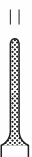





1.4mm			1.0mm		
					
13cm/5"	15cm/6"	18cm/7"	20cm/8"	23cm/9"	
740DE13	740DE15	740DE18	740DE20	740DE23	

French Eye (Ryder) Needle Holder

- Tungsten Carbide Inserts



1.9mm				
				
16cm/6 1/4"	18cm/7"	20cm/8"	26cm/10 1/4"	
739DE16	739DE18	739DE20	739DE26	

RING HANDLED NEEDLE HOLDERS

Fine Touch Needle Holder

- Diamond Dusted Jaws
- Delicate 1mm Jaws
- For 5/0 Sutures or smaller

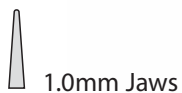

16cm/6 1/4"	MV1018-16
18cm/7"	MV1018-18
22cm/8 3/4"	MV1018-22



Stratte Needle Holder

- Tungsten Carbide Inserts
- Curved to side
- 23cm/9" length

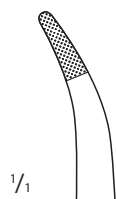

732 DE23 *illustrated



733 DE23 Stratte reverse

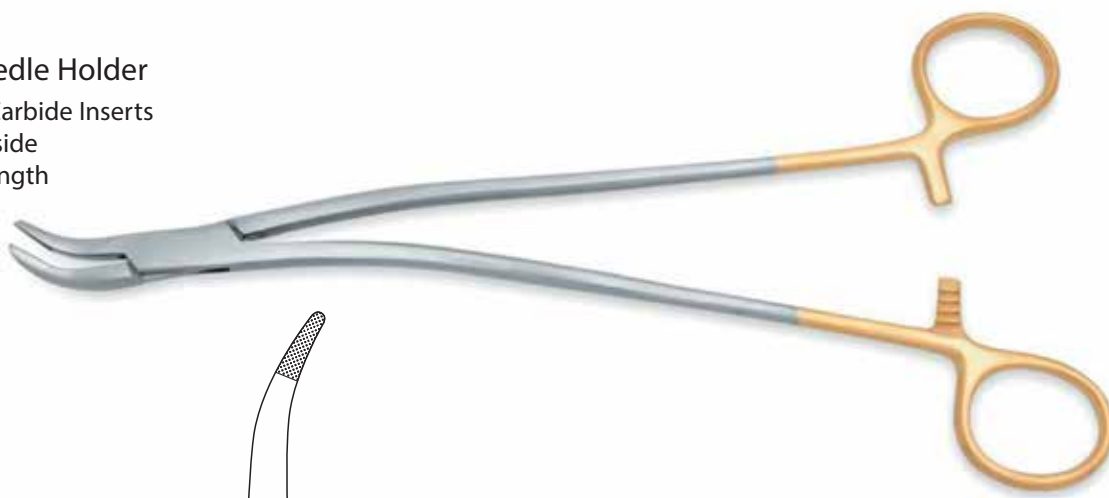

Berry Sternal Needle Holder

- Tungsten Carbide Inserts

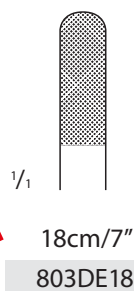

803DE18



DeBakey-Diethrich Atraumatic Tissue Forceps

- Fine 1.5mm Atraumatic Jaws



1/1



15cm/6"	CV2015-15
20cm/8"	CV2015-20
24cm/9 1/2"	CV2015-24

DeBakey Atraumatic Tissue Forceps



1.5mm Tips

2mm Tips

2.8mm Tips

15cm/6"	CV2115-15
20cm/8"	CV2115-20
24cm/9 1/2"	CV2115-24



15cm/6"	CV2120-15
20cm/8"	CV2120-20
24cm/9 1/2"	CV2120-24
30cm/12"	CV2120-30



15cm/6"	CV2128-15
20cm/8"	CV2128-20
24cm/9 1/2"	CV2128-24
30cm/12"	CV2128-30

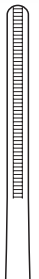

Titanium DeBakey Atraumatic Tissue Forceps



1.5mm Tips

2mm Tips

2.8mm Tips

15cm/6"	CV2115-15T
20cm/8"	CV2115-20T
24cm/9 1/2"	CV2115-24T



15cm/6"	CV2120-15T
20cm/8"	CV2120-20T
24cm/9 1/2"	CV2120-24T



15cm/6"	CV2128-15T
20cm/8"	CV2128-20T
24cm/9 1/2"	CV2128-24T

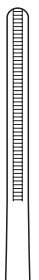

Gillies Dissecting Forceps

- 15cm/6" length
- Toothed

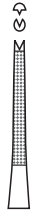

HA5160-15



McIndoes Dissecting Forceps

- 15cm/6" length
- Non-Toothed



CA5170-15



Titanium Cushing Dissecting Forceps

- 18cm/7" length
- Serrated 1mm Tips

CV2001-18T



Adson Bayonet Dissecting Forceps

- 19cm/7 1/2" length
- Flat Handled

CV2003-19 Serrated tip

CV2004-19 Toothed



VASCULAR FORCEPS

Gerald-DeBakey Forceps

- Flat Handled
- 1.2mm DeBakey Tips



17.5cm/6³/₄"
21cm/8¹/₄"

CV2110-17
CV2110-21

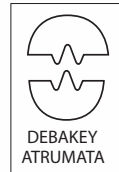

Titanium Gerald-DeBakey Forceps

- Flat Handled
- 1.2mm DeBakey Tips



17.5cm/6³/₄"
21cm/8¹/₄"

CV2110-17T
CV2110-21T

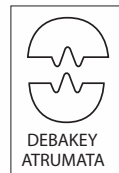

Gerald Tissue Forceps

- Flat Handled
- Tungsten Carbide Tips
- 1.2mm Tips



17.5cm/6³/₄"

CV2111-17



Gerald Plain Forceps

- Flat Handled
- Diamond Dusted Tips
- 1mm Tips



17.5cm/6³/₄"

CV2114-17



Gerald Platform Forceps

- Flat Handled
- Tying platform 6 x 1mm
- Diamond Dusted Tips



17.5cm/6 ³/₄"
21cm/8" ¹/₄

CV2113-17
CV2113-21



Titanium Gerald Platform Forceps

- Flat Handled
- Tying platform 6 x 1mm
- Diamond Dusted Tips



17.5cm/6 ³/₄"
21cm/8" ¹/₄

CV2113-17T
CV2113-21T



Gerald Micro Ring Tip Forceps

- Flat Handled
- 1mm Diamond Dusted Rings



17.5cm/6 ³/₄"
21cm/8" ¹/₄

CV2112-17
CV2112-21



Titanium Gerald Micro Ring Tip Forceps

- Flat Handled
- 1mm Diamond Dusted Rings



17.5cm/6 ³/₄"
21cm/8" ¹/₄

CV2112-17T
CV2112-21T



Micro Platform Forceps

- Diamond Dusted Tips



18cm/7"

MV2201-18

21cm/8" ¹/₄

MV2201-21



Titanium Micro Platform Forceps

- Diamond Dusted Tips



18cm/7"

MV2201-18T

21cm/8" ¹/₄

MV2201-21T



Micro Platform Forceps with Counter Balance

- Diamond Dusted Tips



18cm/7"

MV2203-18

21cm/8" ¹/₄

MV2203-21



Titanium Micro Platform Forceps with Counter Balance

- Diamond Dusted Tips



18cm/7"

MV2203-18T

21cm/8" ¹/₄

MV2203-21T





Micro Ring Tip Forceps

- Diamond Dusted 1mm Ring



18cm/7"

CV2205-18

21cm/8" 1/4

CV2205-21



Titanium Micro Ring Tip Forceps

- Diamond Dusted 1mm Ring



18cm/7"

CV2205-18T

21cm/8" 1/4

CV2205-21T



Micro Ring Tip Forceps with Counter Balance

- Diamond Dusted 1mm Ring



18cm/7"

CV2206-18

21cm/8" 1/4

CV2206-21



Titanium Micro Ring Tip Forceps with Counter Balance

- Diamond Dusted 1mm Ring



18cm/7"

CV2206-18T

21cm/8" 1/4

CV2206-21T



DeBakey Micro Forceps

- Round Bodied
- 1mm DeBakey Tips



18cm/7"

CV2207-18

21cm/8" 1/4

CV2207-21

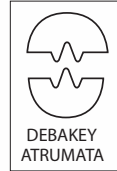

Titanium DeBakey Micro Forceps

- Round Bodied
- 1mm DeBakey Tips



18cm/7"

CV2207-18T

21cm/8" 1/4

CV2207-21T

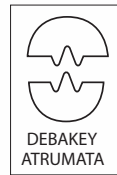

DeBakey Micro Forceps

- Round Bodied
- 1mm DeBakey Tips
- With Counterbalance



18cm/7"

CV2208-18

21cm/8" 1/4

CV2208-21

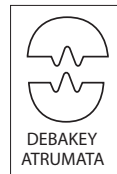

MICRO BAYONET FORCEPS

Bayonet Micro Forceps

- Round Bodied
- Blunt 1mm Tips



21cm/8 1/4"

CV2302-21

23cm/9"

CV2302-23

Yasargil Bayonet Micro Forceps

- Flat Handled
- Blunt 1mm Tips



22.5cm/8 1/4"

CV2301-22

24cm/9 1/2"

CV2301-24

Yasargil Bayonet Tumor Grasping Forceps

- Flat Handled
- 22.5cm/8 1/4" length



Plain Ring

3mm Ø

CV2303-22

5mm Ø

CV2304-22



Serrated Ring

3mm Ø

CV2307-22

5mm Ø

CV2308-22



Toothed Ring

3mm Ø

CV2305-22

5mm Ø

CV2306-22

BIPOLAR FORCEPS

Straight Bipolar Forceps

- 10.5cm/4 1/4" length



Tip Size

0.7mm	70 02 38
1mm	70 02 43
Blunt	70 02 41

Straight Bipolar Forceps

- 16.5cm/6 1/2" length



Tip Size

0.7mm	70 01 52
1mm	70 01 51

Straight Bipolar Forceps

- 19cm/7 1/2" length



Tip Size

0.7mm	70 01 72
1mm	70 01 71

BIPOLAR FORCEPS

Bayonet Bipolar Forceps

- 19cm/7 1/2" length



Tip Size

0.7mm	70 01 83
1mm	70 01 81
2mm	70 01 82

Bayonet Bipolar Forceps

- 22.5cm/8 3/4" length



Tip Size

0.3mm	70 01 90
0.7mm	70 01 91
1.2mm	70 01 92

Bayonet Bipolar Forceps

- 24cm/9 1/2" length



Tip Size

0.3mm	70 02 90
0.7mm	70 02 91
1.2mm	70 02 92

37-01-35L



- Fitting Block End Forceps
- Banana Plug Vallylab Machine Fitting
- 4.5 metre length

37-01-38L



- Fitting Block End Forceps
- Erbe BM780 Machine Fitting
- 4.5 metre length

BIPOLAR FORCEPS

Bayonet Bipolar Coagulation Forceps

- 22.5cm/8 3/4" length
- Non-Stick Tips
- Mallis 2 Pin Fitting



Tip Size

0.5mm	10 - 5402 AU
0.7mm	10 - 5403 AUS/0.7
1.0mm	10 - 5403 AU
1.3mm	10 - 5403 AUS
1.5mm	10 - 5401 AU
2.0mm	10 - 5401 AUS

10 - 6000

• Fitting Mallis Forceps • Banana Plug Fitting



Bipolar Coagulation Unit BM780 MK II

- 70 Watts
- Foot Switch Control

36-00-80-01



36-01-05

Foot Switch



BIPOLAR SCISSORS

Bipolar Clamp

- 23cm/9" length
- Curved jaws



CV7900-23

While bipolar technique is being used, high frequency current flows between the two ends of the bipolar instrument and focuses only on the small surface of tissue placed between them. There is no dangerous flow of current through the patient's body. This minimises the risk of burns in areas that are distant from the surface being operated on. Bipolar techniques are safer than monopolar techniques.

700-731-500

- Bipolar Cable for Bipolar Clamp with 2 banana plugs, 5m length

Bipolar Scissors

- Curved blades
- Metzenbaum Pattern

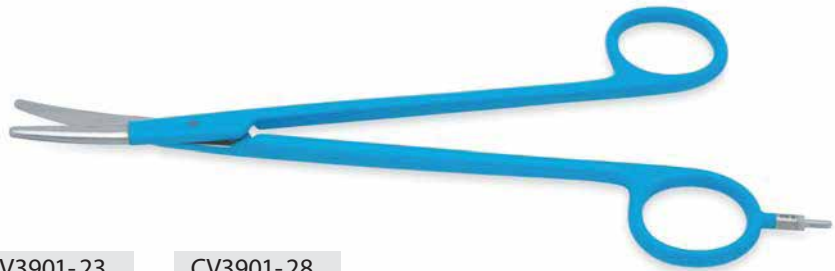

CV3901-18	CV3901-21	CV3901-23	CV3901-28
18cm/7"	21cm/8 1/4"	23cm/9"	28cm/11"

Bipolar Scissors

- Curved slim blades
- Metzenbaum Pattern

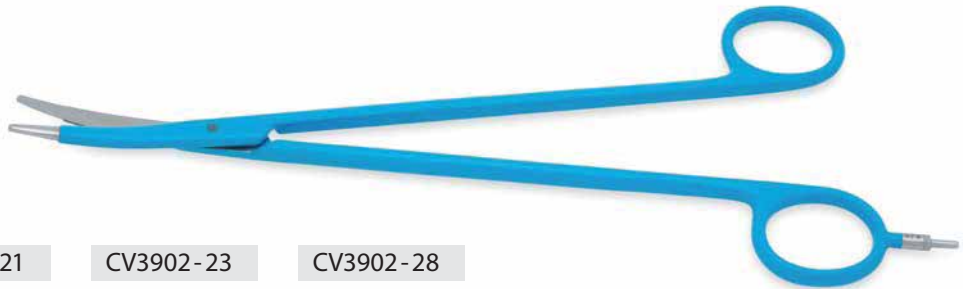

CV3902-18	CV3902-21	CV3902-23	CV3902-28
18cm/7"	21cm/8 1/4"	23cm/9"	28cm/11"

Bipolar Cables

- For use with Bipolar Scissors
- 5 metre cable



700-736-005
Valleylab



700-737-005
Martin



700-739-005
Banana plugs



SCISSORS

Iris Scissors

- 11.5cm/4 1/2" Straight
- Micro Serrated Cutting Edge

CA7612-11



Iris Scissors

- 11.5cm/4 1/2" Curved
- Micro Serrated Cutting Edge

CA7613-11

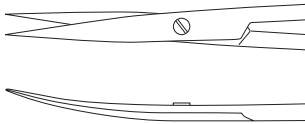

Strabismus Scissors

- 11.5cm/4 1/2" Straight
- Micro Serrated Cutting Edge

CA7622-11



Strabismus Scissors

- 11.5cm/4 1/2" Curved
- Micro Serrated Cutting Edge

CA7623-11



SCISSORS

Stevens Tenotomy Scissors

- 11.5cm/4 1/2" Curved
- Micro Serrated Cutting Edge

CA7633-11

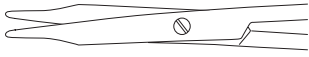

Stevens-Stillle Pattern Tenotomy Scissors

- 12.5cm/5" Curved
- Micro Serrated Cutting Edge
- Larger Oversized Rings

CA7633-12



Jameson-Werber Scissors

- 13.5cm/5 1/4" Curved
- Micro Serrated Cutting Edge

CA7643-13



Jameson Scissors

- 15cm/6" Curved
- Micro Serrated Cutting Edge

CA7643-15



Jameson Scissors

- 15cm/6" Curved
- Strong pattern
- Micro Serrated Cutting Edge

CA7645-15



Slim Baby Metzenbaum Easy-Cut Scissors

- 14cm/5 1/2" Curved
- Micro Serrated Cutting Edge

CA7661-14



Slim Metzenbaum Easy-Cut Scissors

- 18cm/7" Curved
- Micro Serrated Cutting Edge

CA7661-18



Baby Metzenbaum Easy-Cut Scissors

- 14cm/5 1/2" Curved
- Micro Serrated Cutting Edge

CA7663-14



McIndoe / Metzenbaum Easy-Cut Scissors

- 18cm/7" Curved
- Micro Serrated Cutting Edge

CA7663-18



Nelson Metzenbaum Easy-Cut Scissors

- 23cm/9" Curved
- Micro Serrated Cutting Edge

CA7663-23



SCISSORS

Mayo Easy-Cut Scissors

- 14cm/5 1/2" Straight
- Micro Serrated Cutting Edge

CA7652-14

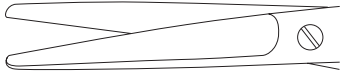

Mayo Easy-Cut Scissors

- 14cm/5 1/2" Curved
- Micro Serrated Cutting Edge

CA7653-14



Mayo Easy-Cut Scissors

- 17cm/6 3/4" Straight
- Micro Serrated Cutting Edge

CA7652-17



Mayo Easy-Cut Scissors

- 17cm/6 3/4" Curved
- Micro Serrated Cutting Edge

CA7653-17



Diethrich Coronary Scissors - Standard Pattern

- 18cm/7" length
- Needle Fine Tips
- Polished Fine Blades
- 12mm Blade length

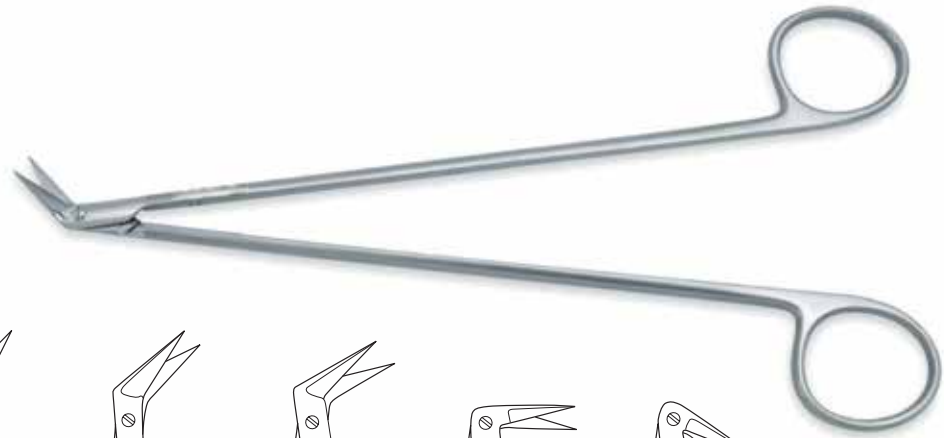

25° angled
CV3025-18



45° angled
CV3045-18



60° angled
CV3060-18

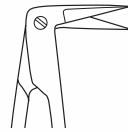

90° angled
CV3090-18



125° angled
CV3012-18

Diethrich Coronary Scissors - Short Fine Blade

- 18cm/7" length
- Needle Fine Tips
- Precise Polished Blades
- 8mm Blade length



25° angled
CV3025-18S



45° angled
CV3045-18S

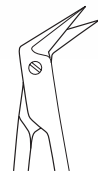

60° angled
CV3060-18S



90° angled
CV3090-18S



125° angled
CV3012-18S

DIETHRICH SCISSORS

Diethrich Coronary Scissors - Extra Long Delicate Blades

- 18cm/7" length
- Needle Fine Tips
- Precise Polished Blades
- 15mm Blade length



25° angled
CV3025-18L



45° angled
CV3045-18L



60° angled
CV3060-18L



90° angled
CV3090-18L

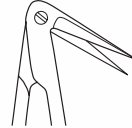

125° angled
CV3012-18L

Diethrich Coronary Scissors - with Guide Rail

- 18cm/7" length
- 12mm Blade length

125° angled blades

CV3012-18G



Favaloro Coronary Scissors

- 17cm/6 3/4" length
- 12mm Blade length

125° angled blades

CV3113-18



Potts-Smith Vascular Scissors

- 19cm/7 1/2" length
- Blades angled to side

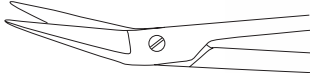

25° angled

CV7625-19

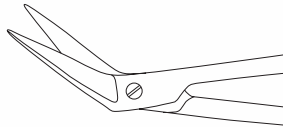

45° angled

CV7645-19

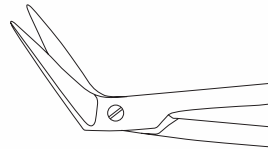

60° angled

CV7660-19

Jacobson Bayonet Micro Scissors

- Flat Handled
- 18cm/7" length



Straight

CV3009-18

Curved

CV3010-18

Yasargil Bayonet Micro Scissors

- Flat Handled
- 22.5cm/8 3/4" length



Standard Blade



Straight

CV3005-22



Curved

CV3006-22

Vannas Blade



Straight

CV3007-22



Curved

CV3008-22

Castroviejo Micro Scissors

- Flat Handled
- 9cm/3" length
- 45° Angled Blades
- 14mm Blade length

CV3045-90



Castroviejo Micro Scissors

- Round Handled
- 11cm/4 1/2" length
- 45° Angled Blades
- 14mm Blade length

CV3145-11



Micro Coronary Scissors - Standard 10mm Blades

- Round Handled - Short length
- 14cm/5 1/2" length
- Blades angled to side



25° angled
CV3125-14



45° angled
CV3145-14



60° angled
CV3160-14



90° angled
CV3190-14



125° angled
CV3112-14

MICRO CORONARY SCISSORS

Micro Coronary Scissors - Standard 10mm Blades

- Round Handled
- 18cm/7" length
- Blades angled to side



25° angled
CV3125-18



45° angled
CV3145-18



60° angled
CV3160-18



90° angled
CV3190-18



125° angled
CV3112-18

Micro Coronary Scissors - Short Fine 8mm Blades

- Round Handled
- 18cm/7" length
- Blades angled to side



25° angled
CV3325-18



45° angled
CV3345-18



60° angled
CV3360-18



90° angled
CV3390-18



125° angled
CV3312-18

MICRO CORONARY SCISSORS

Micro Coronary Scissors - Standard 10mm Blades

- Flat Handled
- 18cm/7" length
- Blades angled to side



25° angled
MV3425-18



45° angled
MV3445-18



60° angled
MV3460-18

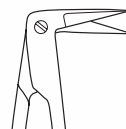

90° angled
MV3490-18



125° angled
MV3412-18

Micro Coronary Scissors - Short Fine 8mm Blades

- Flat Handled
- 18cm/7" length
- Blades angled to side



25° angled
CV3625-18



45° angled
CV3645-18



60° angled
CV3660-18



90° angled
CV3690-18



125° angled
CV3612-18

MICRO SCISSORS

Straight Micro Scissors

- Flat Handled
- 15cm/6" length
- Blades 19mm long

CAS-15



Adventitia Scissors with pointed tips

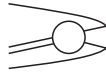

CAS-15T

Available with Micro Serrations for nerve cutting -Straight

Curved Micro Scissors

- Flat Handled
- 15cm/6" length
- Blades 19mm long

CDC-15



Dissecting Scissors with rounded tips

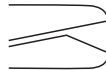

CDC-15T

Available with Micro Serrations for nerve cutting -Curved

Straight Micro Scissors

- Flat Handled
- 15cm/6" length
- Blades 15mm long

CAS-15S



Adventitia Scissors with pointed tips

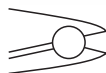

Curved Micro Scissors

- Flat Handled
- 15cm/6" length
- Blades 15mm long

CDC-15S



Dissecting Scissors with rounded tips

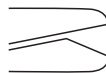

MICRO SCISSORS

Straight Micro Scissors

- Round Handled
- 15cm/6" length
- Blades 12mm long

CAS-15 R8



Adventitia Scissors with pointed tips

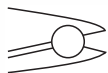

Curved Micro Scissors

- Round Handled
- 15cm/6" length
- Blades 12mm long

CDC-15 R8



Dissecting Scissors with rounded tips



Straight Micro Scissors

- Round Handled
- 18cm/7" length
- Blades 14mm long

CAS-18 R8



Adventitia Scissors with pointed tips

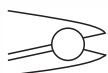

Curved Micro Scissors

- Round Handled
- 18cm/7" length
- Blades 14mm long

CDC-18 R8



Dissecting Scissors with rounded tips



RIB SPREADERS

Titanium Neonates Sternal Spreader

- Including 2 pairs of Interchangeable Blades
- 52mm spread, 40mm arm length

CV5001-14



Fenestrated
Blades x2
10mm width
15mm depth



Solid
Blades x2
20mm width
15mm depth



Morse-Favaloro Sternal Spreader

- Double Swivel Blades

Code	Arm length	Blade depth	Size
CV5002-12	55mm	12mm	Infant
CV5002-13	70mm	13mm	Infant
CV5002-14	80mm	14mm	Paediatric
CV5002-15	95mm	15mm	Paediatric
CV5002-16	110mm	19mm	Adolescent
CV5002-19	130mm	19mm	Adolescent
CV5002-21	145mm	21mm	Adolescent



Waterston Rib Spreader

- Infant size

CV5003-20



Arm length Blade width Blade depth

195mm 40mm 20mm

RIB SPREADERS

Finochietto Rib Spreader



Code	Blade width	Blade depth	Spread
CV5004-18	21mm	18mm	85mm
CV5004-36	45mm	36mm	150mm
CV5004-44	65mm	44mm	225mm
CV5004-50	60mm	50mm	225mm
CV5004-65	65mm	65mm	225mm

Sellors Rib Spreader

CV5011-00

Supplied with set of 3 sizes of Blades and Key

Small Blade	38mm Depth
Medium Blade	45mm Depth
Large Blade	65mm Depth

- Max spread 225mm



38mm Depth
Small Blade



45mm Depth
Medium Blade



65mm Depth
Large Blade



Key

RIB SPREADERS

Tuffier Rib Spreader

CV5005-50

Blade width Blade depth

45mm

50mm



Tudor Edwards Modified Tuffier Rib Spreader

- Complete with key

CV5006-35

Blade width Blade depth

25mm

35mm



Key

Tudor Edwards Rib Spreader

CV5007-00

Supplied with set of 3 sizes of Blades and Key

Small Blade	25mm Depth
Medium Blade	50mm Depth
Large Blade	75mm Depth



25mm Depth
Small Blade



50mm Depth
Medium Blade



75mm Depth
Large Blade



Key

RIB SPREADERS

Ronald Edwards Rib Spreader

- Curved arms, fenestrated Blades



Code		Blade width	Blade depth	Spread
CV5008-50	Medium	30mm	50mm	135mm
CV5008-75	Large	65mm	75mm	205mm

Papworth Rib Spreader

- 225mm spread

CV5009-25



Blade width	Blade depth
65mm	25mm

RIB SPREADERS

Sellors Rib Approximator and Spreader Combined

- 20cm/8" length

CV5010-00



IMA Rib Retractor

- Complete Set for Internal Mammary Artery Surgery
- Converts left or right side

Complete set includes:

- Frame
- Channelled Blade 100mm
- Claw Blade short 28mm
- Claw Blade long 32mm

CV5014-00

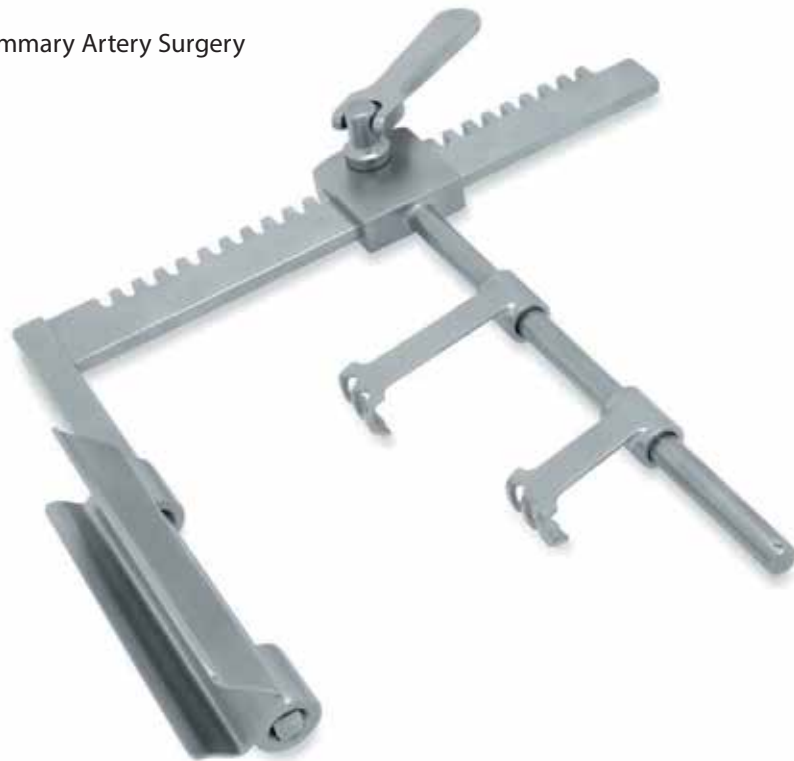

Channelled Blade

- 100mm long x 20mm wide



Claw Blades



Lengths

- 28mm *
- 32mm *
- 38mm
- 43mm
- 50mm

* included in Set

RIB SPREADERS

Cooley Cosgrove Mitral Valve Retractor

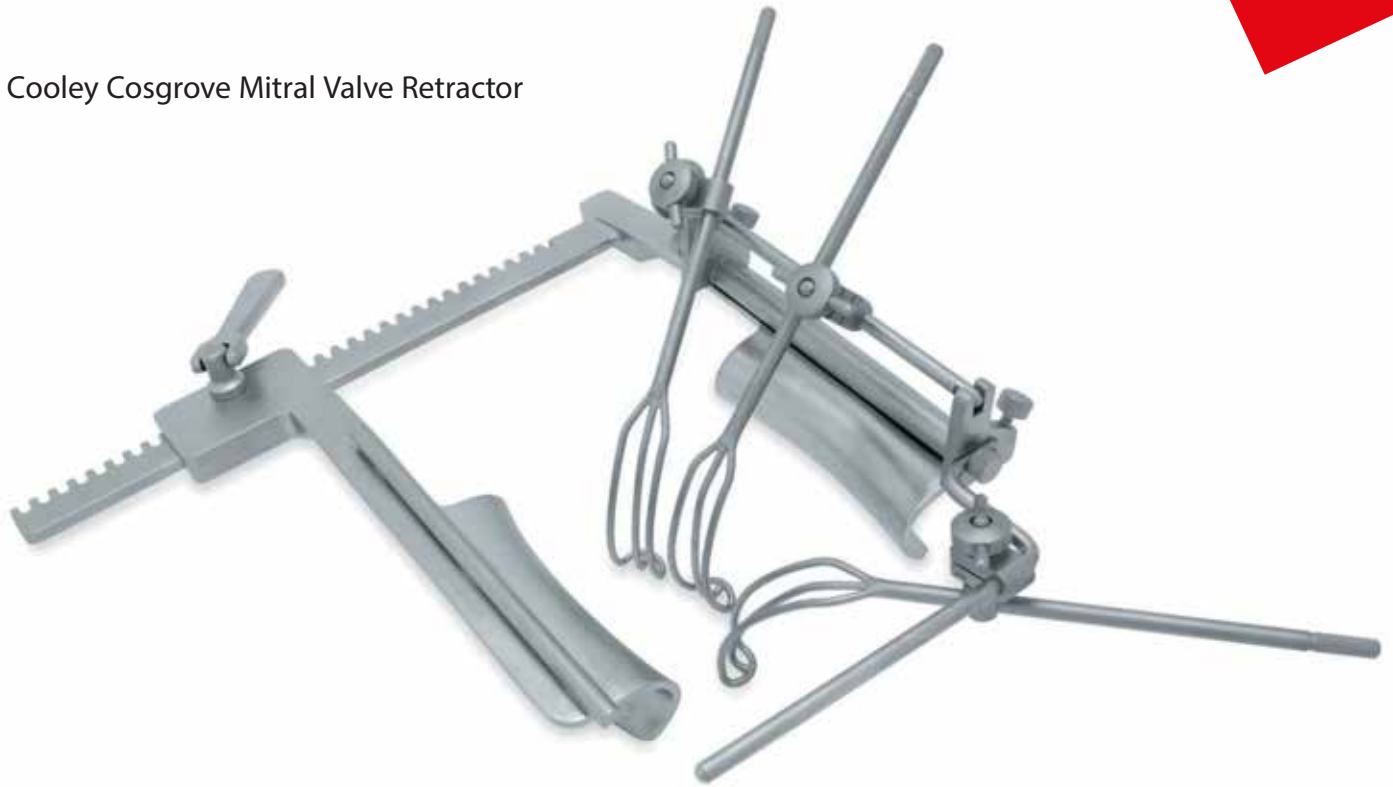

CV5012-00 Complete Set

Consisting of:

- 1x Cooley Rib Spreader Adult Blades 40mm x 110mm with Cosgrove Mounting Bars
- 1x Main Bracket Attachment
- 3x Universal Clamps
- 1x Side Arm Bar
- 1x Tricuspid Retractor Blade
- 1x Large Retractor Blade
- 3x Small Retractor Blades



Retractor Blade Large

CV5012-01



Retractor Blade Small

CV5012-02



Tricuspid Retractor Blade

CV5012-03

Universal Clamp



MV5012-06



Main Bracket Attachment

CV5012-05

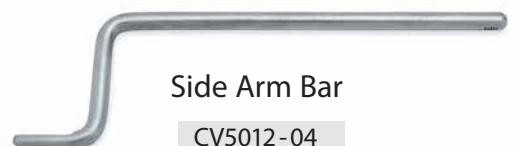

Side Arm Bar

CV5012-04

ABDOMINAL RING RETRACTOR

Abdominal Ring Retractor System

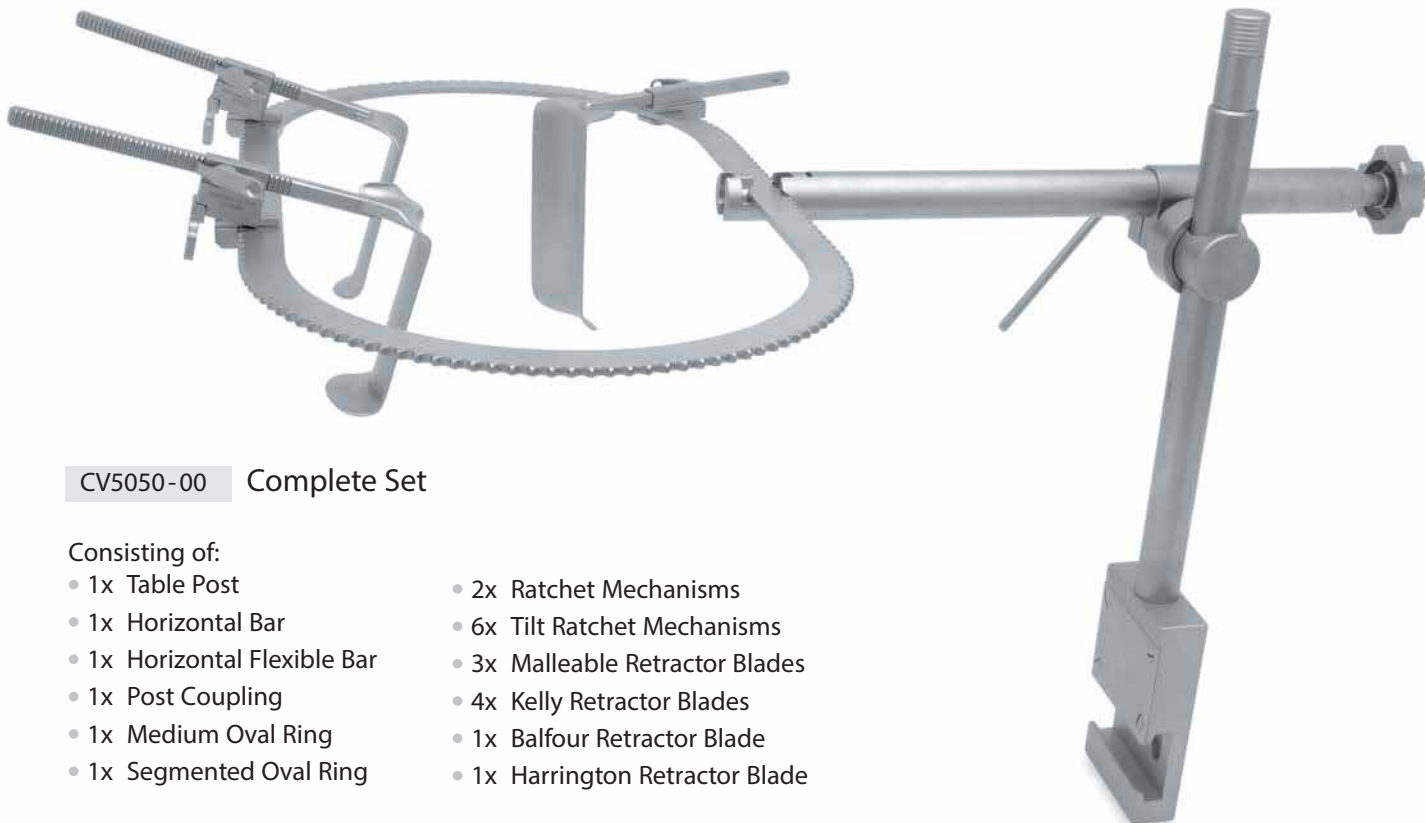

CV5050-00 Complete Set

Consisting of:

- 1x Table Post
- 1x Horizontal Bar
- 1x Horizontal Flexible Bar
- 1x Post Coupling
- 1x Medium Oval Ring
- 1x Segmented Oval Ring
- 2x Ratchet Mechanisms
- 6x Tilt Ratchet Mechanisms
- 3x Malleable Retractor Blades
- 4x Kelly Retractor Blades
- 1x Balfour Retractor Blade
- 1x Harrington Retractor Blade

Components:

Table Post

CV5051-00



Horizontal Bar

CV5052-00



Horizontal Flexible Bar

CV5053-00



Post Coupling

CV5054-00



Ratchet Mechanism

CV5057-00



Tilt Ratchet Mechanism

CV5058-00



ABDOMINAL RING RETRACTOR

Medium Oval Ring

MV5055-00



Segmented Oval Ring

MV5056-00

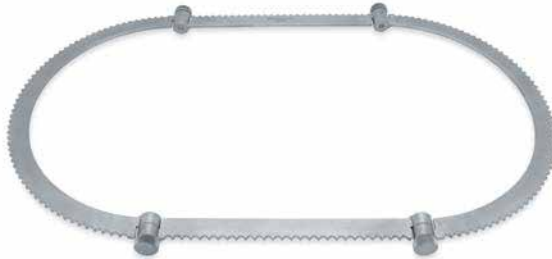

Malleable Retractor Blades

Code	Blade Size	
	width	depth
CV5060-01	38mm	152mm
CV5060-02	51mm	152mm
CV5060-03	76mm	152mm



Kelly Retractor Blades

Code	Blade Size	
	width	depth
CV5061-01	51mm	76mm
CV5061-02	51mm	102mm
CV5061-03	51mm	127mm
CV5061-04	51mm	154mm



Balfour Retractor Blade

Code	Blade Size	
	width	depth
CV5062-01	67mm	76mm



Harrington Retractor Blade

Code	Blade Size	
	width	depth
CV5063-01	63mm	143mm



Jacobson Micro Vessel Probe

- 18.5cm/7 1/4"
- Probe with ball tip



CV9109-18

Krayenbühl Nerve and Vessel Hook

- 18.5cm/7 1/4"



CV9111-18

CV9112-18

MV9113-18

MV9114-18



Adson Dural Hook

- 19cm/7 1/2"
- 2mm tip length

Sharp

CP9103-19

Blunt

CP9104-19



Cushing Blunt Hook

- 19cm/7 1/2"
- 3mm tip length

CV9101-19



Crile Blunt Hook

- 20cm/8"
- 7mm tip length

SP9111-20



Adson Hook

- 20cm/8"
- 5mm tip length

Sharp

CP9101-20

Blunt

CP9102-20



Blalock Blunt Hook

- 24cm/9 1/2"
- 5mm tip length

CP9108-24



Gillies Skin Hook

- 18cm/7"

CA5065-01 Small size

CA5065-02 Large size



Klienert-Kutz Skin Hook

- 16cm/6 1/4"

CA5055-01



Ragnell-Davies Retractor

- 14cm/5 1/2"

CA5287-14



Mini-Langenbeck Retractor

- 16cm/6 1/4"

CA5242-10 10 x 6mm *illustrated

CA5242-17 17 x 5mm



Desmarres Saddle Retractor

- 16cm/6 1/4"
- 12mm width

CA5235-12



Senn-Miller Double Ended Catspaw Retractor

- 16cm/6 1/4"

CA5289-01 Sharp prongs

CA5289-02 Blunt prongs



Kilner-Miniature Pattern Catspaw Retractor

- 15cm/6"

CA5286-01



RETRACTORS

Langenbeck Retractor

- 21.5cm/8 1/2"



Code	Blade Size		
	depth	width	
CP5122-21	22mm	6mm	Small
CP5145-21	45mm	13mm	Medium
CP5165-21	65mm	25mm	Large
CP5190-21	90mm	20mm	X-large

Morris Retractor

- 25cm/9 3/4"



Code	Blade Size	
	depth	width
CP5201-40	50mm	40mm
CP5201-50	50mm	50mm
CP5201-65	50mm	65mm
CP5202-40	70mm	40mm
CP5202-50	70mm	50mm
CP5202-65	70mm	65mm

Deavers Abdominal Retractor

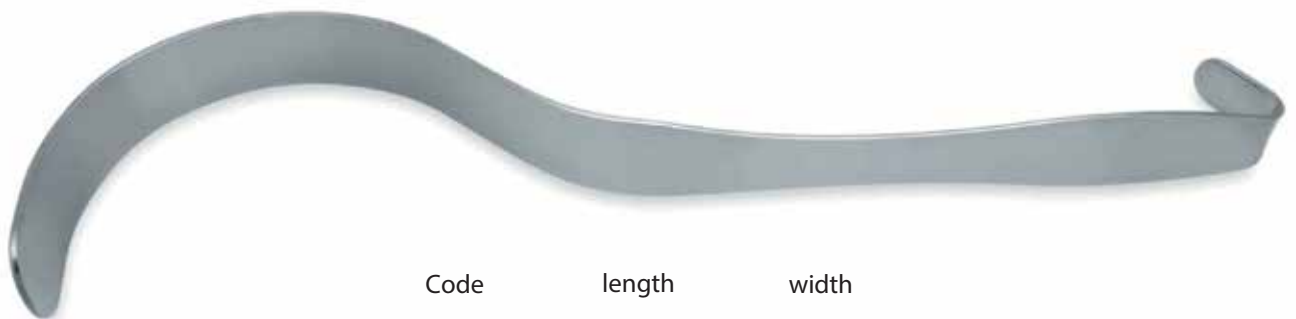

Code	length	width
CV5100-25	300mm	25mm
CV5100-30	350mm	25mm
CV5100-38	300mm	38mm
CV5100-50	300mm	50mm
CV5100-75	300mm	75mm

RETRACTORS

Tudor Edwards Scapula Retractor

- 20cm/8"
- Toothed blade 50mm x 45mm



CV5205-20

Brompton Erector Spinae Retractor

- Hollow handle
- 20cm/8"
- 2 Prong blades



CV5204-20

Brock Erector Spinae Retractor

- Hollow handle
- 20cm/8"



CV5203-20

Allison Lung Retractor



Code length

CV5202-28	Infant	28cm
CV5204-28	Child	28cm
CV5206-30	Adult	30cm

Ross Aortic Retractor

- 26cm/10 1/2"



Code width Code width

CV5210-10	No.1	MV5210-40	No.4
CV5210-20	No.2	MV5210-50	No.5
CV5210-30	No.3	MV5210-60	No.6

RETRACTORS

Baby Weitlaner S/R Retractor

- 2 x 3 Blunt Prongs
- 11.5cm/4 1/2"

CA5701-10



West's S/R Retractor

- 3 x 4 Sharp Prongs
- 14cm/5 1/2"

CP4003-14



Travers S/R Retractor

- 4 x 5 Blunt Prongs
- 20cm/8"

CP4004-20



Norfolk and Norwich S/R Retractor

- 4 x 5 Blunt Prongs
- 20cm/8"

SP4000-20



RIB RASPATORY

Doyen Periosteal Elevator - Right

CV7001-15 Child - 15cm length

CV7002-16 Adult - 16.5cm length



Doyen Periosteal Elevator - Left

CV7003-15 Child - 15cm length

CV7004-16 Adult - 16.5cm length



Price Thomas Rib Raspatory

CV7005-12 12mm width

CV7005-20 20mm width



Semb Rib Raspatory



No.1 short shaft, notched end for rib edge, 200mm

CV7006-20



No.2 long shaft, notched end for rib edge, 235mm

CV7006-23



No.3 short shaft, straight end, 190mm

CV7007-19



No.4 long shaft, straight end, 250mm

CV7007-25



No.5 short shaft, oval blade, 220mm

CV7008-22



No.6 short shaft, angled oval end for back of first rib, 195mm

CV7009-19



No.7 long shaft, for edge of first rib, 250mm

CV7010-25



No.8 chisel end for disarticulation of costovertebral joint, 200mm

CV7011-20

RIB CUTTERS

Stille-Liston Bone Cutters

- Double Action
- Straight
- 27cm/10 ³/₄"

CP1024-27



Liston-Key-Horsley Bone Cutters

- Double Action
- Angled
- 27cm/10 ³/₄"

CP1023-27



Tudor Edwards/Vehmehren Costotome

- 24cm/9 ¹/₂"
- For Cutting Ribs

CP1023-24



WIRE CUTTERS

Muller Claus Wire Cutters

- 16cm/6"
- Tungsten Carbide Edges
- Cuts wire up to 1.6mm Ø

8-810E16



Muller Claus Wire Cutters

- Tungsten Carbide Edges

8-810E18

- 18cm/7" length (*illustrated)
- Cuts wire up to 2mm Ø

8-800E22

- 22cm/8 3/4" length
- Cuts wire up to 3mm Ø



End Wire Cutters

- 18cm/7" length
- Tungsten Carbide Edges
- Cuts wire up to 1.7mm Ø

8-816E18



Muller Claus Wire Pullers

- 18cm/7" length

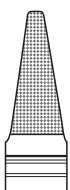

2mm Jaws

8-818E18

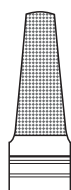

4mm Jaws

8-820E18

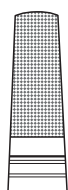

6mm Jaws

8-821E18



Titanium Micro Round Dissectors

• 19cm/7 1/2"



1mm Small

CV8101-19



2mm Medium

CV8102-19



3mm Large

CV8103-19



Titanium Micro Elevators

• 19cm/7 1/2"



Curved

CV8104-19



Angled

CV8105-19



Titanium Micro Spatula Dissectors

• 19cm/7 1/2"



1mm Small

CV8106-19



1.7mm Medium

CV8107-19



2mm Large

CV8108-19



Titanium Micro Hooks

• 19cm/7 1/2"



90° Semi-sharp

CV8109-19



90° Blunt

CV8110-19



45° Semi-sharp

CV8111-19



Straight point Needle

CV8112-19



Titanium Micro Curettes

• 19cm/7 1/2"



Small Cup

CV8113-19



Large Cup

CV8114-19



DISSECTORS

Titanium Micro Ball Dissectors

- 19cm/7 1/2"



Straight

CV8115-19



90° 3mm Tip

CV8116-19



90° 5mm Tip

CV8117-19



40° 4mm Tip

CV8118-19



40° 8mm Tip

CV8119-19

Dissector Sterilising Rack

- To hold 19 Micro Dissectors

MV8100-00



Complete Set

- Including Rack and 19 Micro Dissectors

MV8100-19

MacDonalds Dissector

- 19cm/7 1/2"

CA7105-19



Watson Cheyne Dissector

CA7203-12 12.5cm/5"

CA7203-18 18cm/7"



Freer Dissector

- 19cm/7 1/2"

CA7602-18



ACL AND MICRO CLAMPS

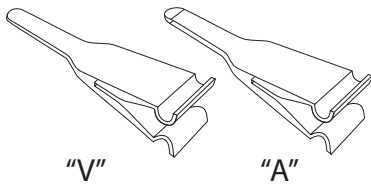

"A" or "V" Pattern?

Throughout the series, the "V" pattern is the all-purpose clamp, commonly used on all veins, and almost all arteries. The "A" pattern, available in all sizes, is designed for exceptionally thick-walled vessels and slippery arteries. The slight incurve of the tips of the "A" pattern jaw provides extra security against slippage.

- Light and compact design
- Extremely durable
- A unique gripping surface
- Smooth sliding bar action on all approximator clamps
- Clamp profile with parallel sided jaws
- Matt or black finish















Acland
Clamp Container
CV4400-00

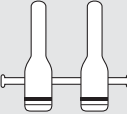
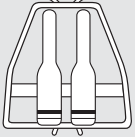

Double
Clamps

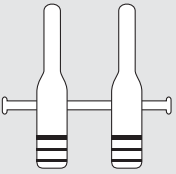
Single
Clamps

Ordering details

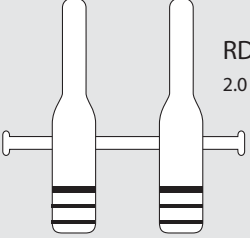
SINGLE CLAMPS	DOUBLE APPROXIMATING CLAMPS	DOUBLE CLAMPS WITH FRAME
00396 V 00397 A  CLAMP SIZE B - 1 0.4 - 1.0mm	00414 V 00415 A  CLAMP SIZE ABB - 11 0.4 - 1.0mm	00408 V 00409 A  CLAMP SIZE ABB - 1 0.4 - 1.0mm
00398 V 00399 A  CLAMP SIZE B - 2 0.6 - 1.5mm	00416 V 00417 A  CLAMP SIZE ABB - 22 0.6 - 1.5mm	00410 V 00411 A  CLAMP SIZE ABB - 2 0.6 - 1.5mm
00400 V 00401 A  CLAMP SIZE B - 3 1.0 - 2.25mm	00418 V 00419 A  CLAMP SIZE ABB - 33 1.0 - 2.25mm	00412 V 00413 A  CLAMP SIZE ABB - 3 1.0 - 2.25mm
00325  CLAMP SIZE HD - S 1.5 - 3.5mm	00326  CLAMP SIZE HD - D 1.5 - 3.5mm	 Clamp Box CB-1  Clamp Applicator CAF-4
00286  CLAMP SIZE RD - S 2.0 - 5.0mm	00287  CLAMP SIZE RD - D 2.0 - 5.0mm	

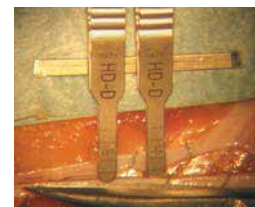

DISPOSABLE VESSEL CLAMPS

- Sterile, single use, disposable
- Atraumatic jaws
- Colour coded for better differentiation
- Consistent and reliable closing pressure
- Designed for use on veins and arteries
- Light weight
- Blue, black and purple finish provides excellent contrast in the field
- Radiopaque
- Eliminates cleaning and processing problems
- Economical

Single Clamps



Double Clamps



VISIBILITY BACKGROUND MATERIAL

TO ASSIST IN VISUALISING MICRO VESSELS DURING SURGERY

Application: For use in Micro Surgical Anastomosis of Micro Vessels under a Microscope to allow the surgeon to better visualize the detail of the vessels, being closed.

The Visibility Material can be used either with the Grid side up to give the Surgeon a scale of the vessel alternatively the reverse Plain side can also be used.

The material has a non reflective surface eliminating distractions from theatre lighting and has a non-tacky finish to aid mobilization of the Vessel.

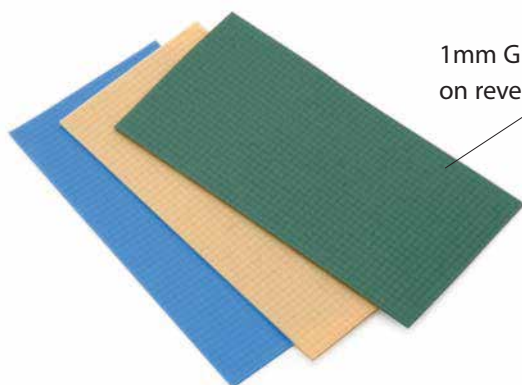

1mm Grid one side & matt finish on reverse. Size: 50mm x 25mm

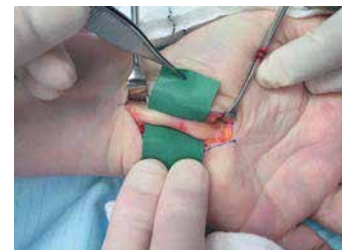
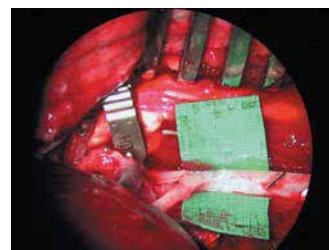

Ordering details:

COLOUR	ordering code
Yellow	VB2
Green	VB3
Blue	VB4

- X-Ray opaque silicon material
- 1mm Grid for accurate measurement of vessels
- Latex Free material
- Sterile Packed in boxes of 12 pieces

BULLDOG CLAMPS

Diethrich Mini Bulldog Clamps

- Straight
- Weight 3gr
- Closing pressure 80gr



Overall length
Jaw length

50mm
8mm
CV4001-50



55mm
12mm
CV4001-55



60mm
16mm
CV4001-60



65mm
20mm
CV4001-65

Code

Diethrich Mini Bulldog Clamps

- Angled
- Weight 3gr
- Closing pressure 80gr



Overall length
Jaw length

43mm
8mm
CV4002-43

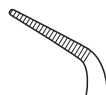

45mm
12mm
CV4002-45

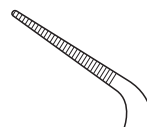

50mm
16mm
CV4002-50

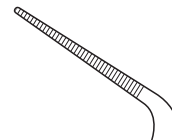

55mm
20mm
CV4002-55

Code

BULLDOG CLAMPS

DeBakey-Diethrich Mini Bulldog Clamps

- Straight
- Weight 3gr
- Closing pressure 180gr

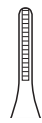

47mm
10mm

CV4005-47

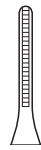

51mm
14mm

CV4005-51

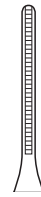

57mm
20mm

CV4005-57

Overall length
Jaw length

Code

DeBakey-Diethrich Mini Bulldog Clamps

- Angled
- Weight 3gr
- Closing pressure 180gr



44mm
10mm

CV4006-44

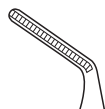

46mm
14mm

CV4006-46

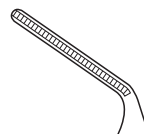

49mm
20mm

CV4006-49

Overall length
Jaw length

Code





BULLDOG CLAMPS

Low Closing Pressure for Veins 110gr marked with V
 High Closing Pressure for Arteries 220gr marked with A

Titanium Mini Glover Bulldog Clamps

- Straight
- Weight 0.8gr







				
Overall length	30mm	35mm	40mm	50mm
Jaw length	11mm	15mm	17mm	24mm
Vein	CV4009-30T	CV4009-35T	CV4009-40T	CV4009-50T
Low Closing Pressure				
Arterial	CV4010-30T	CV4010-35T	CV4010-40T	CV4010-50T
High Closing Pressure				

Titanium Mini Glover Bulldog Clamps

- Curved
- Weight 0.8gr







				
Overall length	30mm	35mm	40mm	50mm
Jaw length	11mm	15mm	17mm	24mm
Vein	CV4011-30T	CV4011-35T	CV4011-40T	CV4011-50T
Low Closing Pressure				
Arterial	CV4012-30T	CV4012-35T	CV4012-40T	CV4012-50T
High Closing Pressure				

Titanium Mini Glover Bulldog Clamps

- Strongly Curved
- Weight 0.8gr



				
Overall length	30mm	35mm	40mm	50mm
Jaw length	11mm	15mm	17mm	24mm
Vein	CV4013-30T	CV4013-35T	CV4013-40T	CV4013-50T
Low Closing Pressure				
Arterial	CV4014-30T	CV4014-35T	CV4014-40T	CV4014-50T
High Closing Pressure				

BULLDOG CLAMPS

Glover Bulldog Clamps

- Straight
- Closing Pressure adjustable

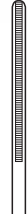

Overall length
Jaw length

50mm
20mm

Code

CV4007-50



68mm
30mm

CV4007-68



85mm
43mm

CV4007-85



105mm
56mm

CV4007-05

Glover Bulldog Clamps

- Curved
- Closing Pressure adjustable

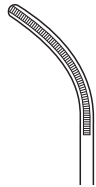

Overall length
Jaw length

46mm
20mm

Code

CV4008-50



64mm
30mm

CV4008-68

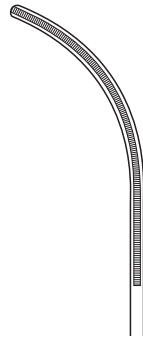

78mm
43mm

CV4008-85



100mm
56mm

CV4008-05

Mini-Glover Bulldog Clamps

- Weight 12g



Overall length
Jaw length

35mm
14mm

Code

CV4015-35



35mm
14mm

CV4025-35



35mm
14mm

CV4035-35

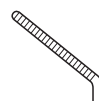

35mm
14mm

CV4045-35

BULLDOG CLAMPS

Glover Bulldog Clamps

- Angled
- 55mm length Jaws

CV4056-55

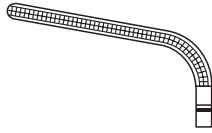

DeBakey-Satinsky Bulldog Clamps

- Curved
- 55mm length Jaws

CV4057-55

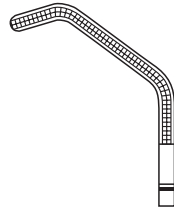

DeBakey Carotid Bulldog Clamps

- Curved
- 90mm length Jaws

CV4058-90

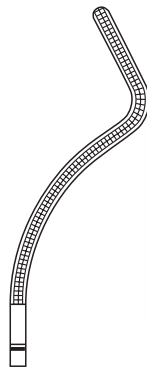

DeBakey-Satinsky Bulldog Clamps

- Curved
- 100mm length Jaws

CV4059-100

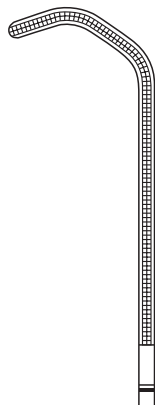

BULLDOG CLAMPS

Gregory 'Soft' Carotid Bulldog Clamps

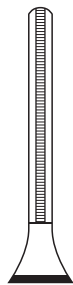

90mm
27mm

MV4050-90

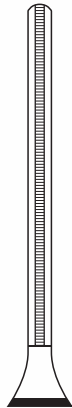

110mm
44mm

MV4051-11

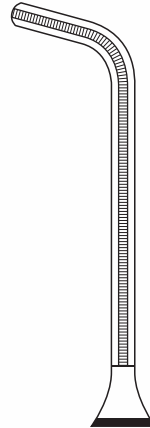

105mm
55mm

MV4052-10

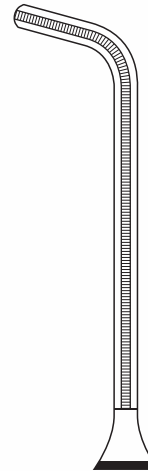

110mm
60mm

MV4053-11

Overall length
Jaw length

Code

Modified Gregory 'Soft' Bulldog Clamps

- Curved
- Weight 12g

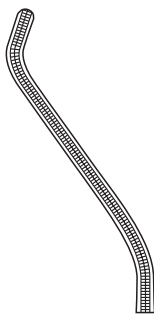

110mm
60mm

CV4054-11

curved to left

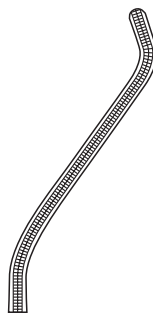

110mm
60mm

CV4055-11

curved to right

Overall length
Jaw length

Code

BULLDOG CLAMPS

DeBakey Bulldog Clamps

- Straight

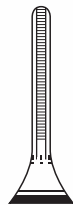

80mm
20mm

CV4003-08

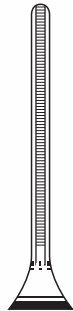

90mm
30mm

CV4003-09

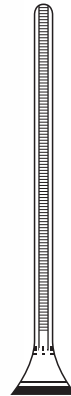

105mm
45mm

CV4003-10

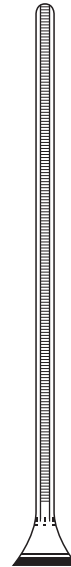

125mm
68mm

CV4003-12

Overall length
Jaw length

Code

DeBakey Bulldog Clamps

- Curved

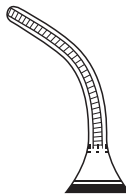

75mm
20mm

CV4004-08

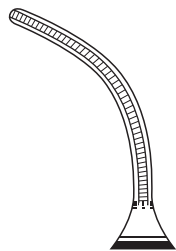

85mm
30mm

CV4004-09

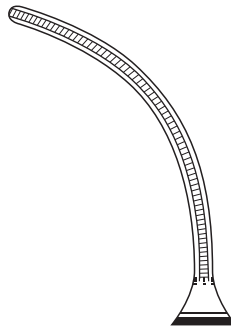

95mm
45mm

CV4004-10

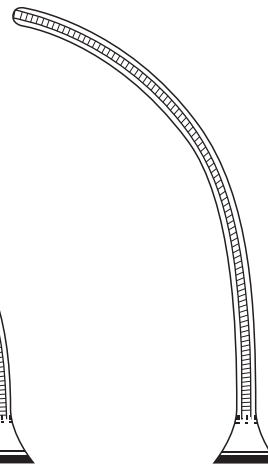

115mm
68mm

CV4004-12

Overall length
Jaw length

Code

BULLDOG CLAMPS

Titanium DeBakey Bulldog Clamps

- Straight

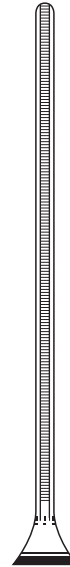
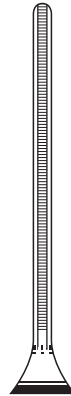
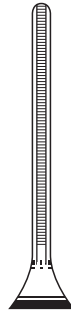
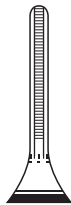

Overall length
Jaw length

80mm
20mm

90mm
30mm

105mm
45mm

125mm
68mm

Code

CV4003-08T

CV4003-09T

CV4003-10T

CV4003-12T

Titanium DeBakey Bulldog Clamps

- Curved

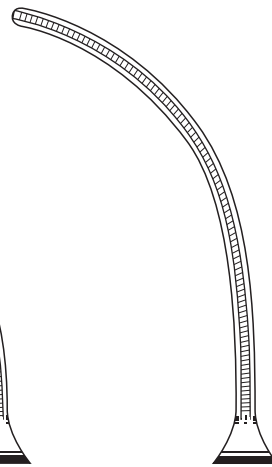
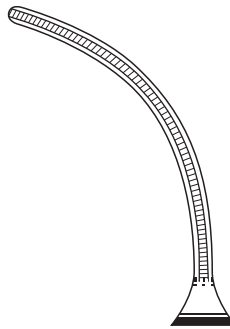
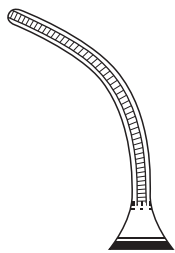
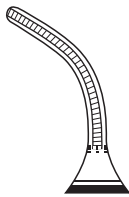

Overall length
Jaw length

75mm
20mm

85mm
30mm

95mm
45mm

115mm
68mm

Code

CV4004-08T

CV4004-09T

CV4004-10T

CV4004-12T

VASCULAR CLAMPS

Titanium DeBakey Paediatric Clamp

- 10.5cm/4" length
- Straight Jaws/Angled Shanks

CV6010-10T



Titanium DeBakey Paediatric Clamp

- 10.5cm/4" length

CV6011-10T Jaws angled 30°

CV6012-10T Jaws angled 45°

CV6013-10T Jaws angled 60°



Titanium DeBakey Paediatric Clamp

- 10.5cm/4" length
- Jaws 6mm x 10.5mm

CV6014-10T



Titanium DeBakey Paediatric Clamp

- 10.5cm/4" length
- Jaws 6mm x 10.5mm

CV6015-10T



Titanium DeBakey Paediatric Clamp

- 10.5cm/4" length
- Jaws 9mm x 10.5mm

CV6016-10T



VASCULAR CLAMPS

DeBakey Castaneda Paediatric Clamp

- Curved shanks
- Suitable for Paediatric and delicate surgery
- 12cm/5" length



*illustrated

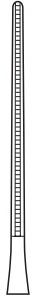

CV6301-12

Straight

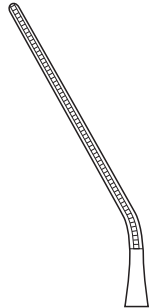

CV6302-12

Angled 25°

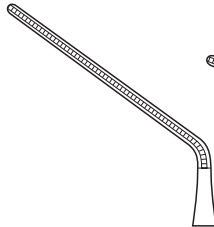

CV6303-12

Angled 45°

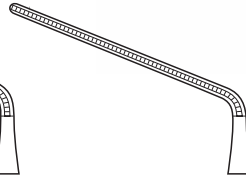

CV6304-12

Angled 60°

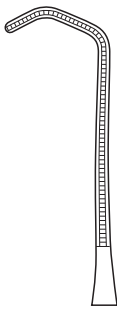

CV6305-12

Anastomosis

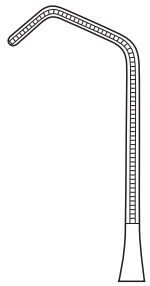

CV6306-12

Anastomosis

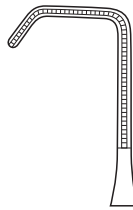

CV6307-12

Anastomosis 90°

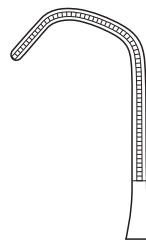

CV6308-12 *

Satinsky

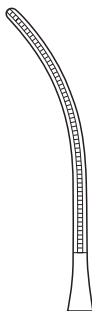

CV6309-12

Light curve



CV6310-12

Spoon shaped

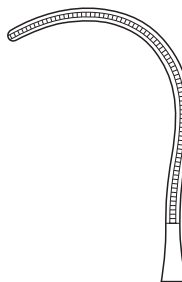

CV6311-12

Strong curve

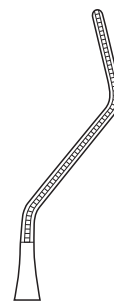

CV6312-12

Carotid

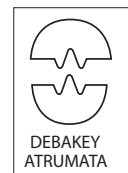

VASCULAR CLAMPS

DeBakey Ring Handled Bulldog Clamp

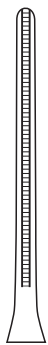

CV6041-12 straight
12.5cm/5"

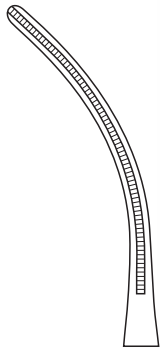

CV6042-12 curved
12.5cm/5"

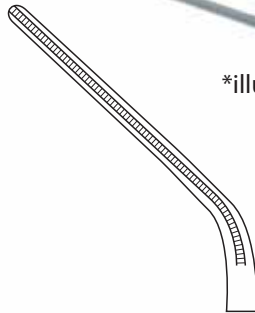

CV6043-12 *angled 45°
12.5cm/5"

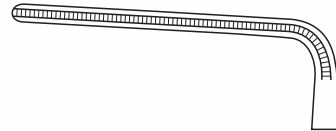

CV6044-12 angled 90°
10cm/4"



*illustrated

DeBakey-Glover Anastomosis Clamp

- Straight shanks

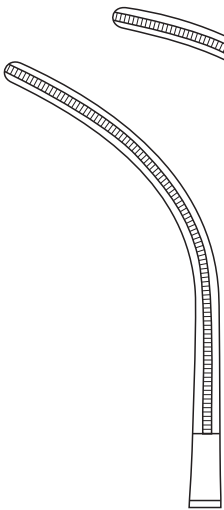

CV6020-21
21cm/8 1/4"

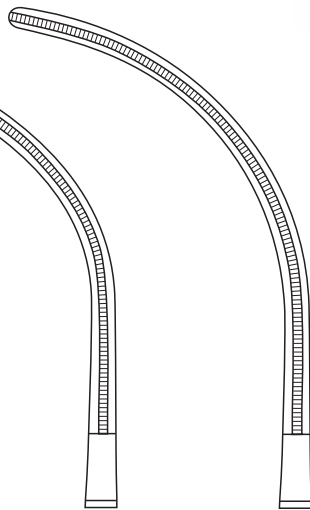

CV6021-24
24cm/9 1/2"

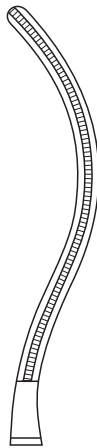

CV6022-21
21cm/8 1/4"

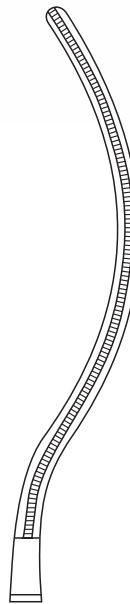

CV6023-26
26cm/10 1/4"

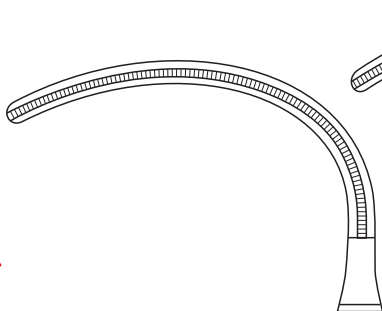

CV6024-18
18.5cm/7 1/4"

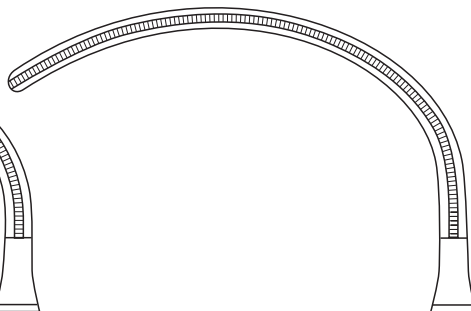

CV6025-22
22cm/8 3/4"

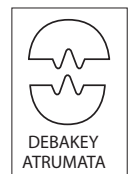

VASCULAR CLAMPS

Lambert-Kay Aortic Clamp

- 20cm/8" length

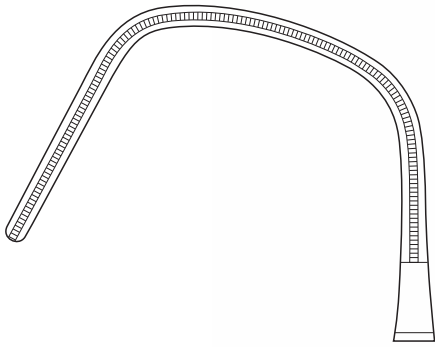
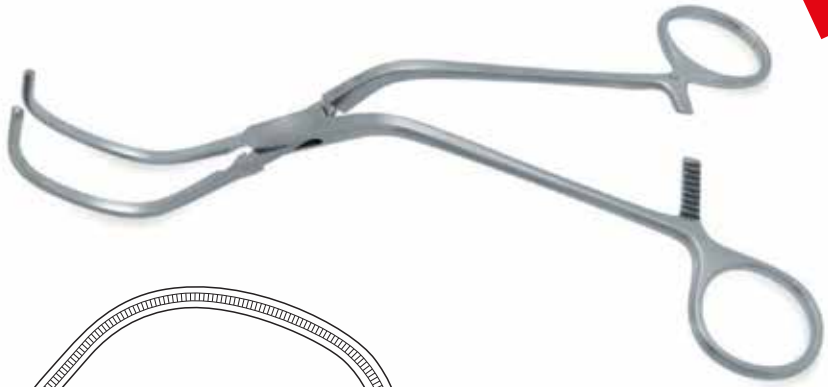

CV6030-20

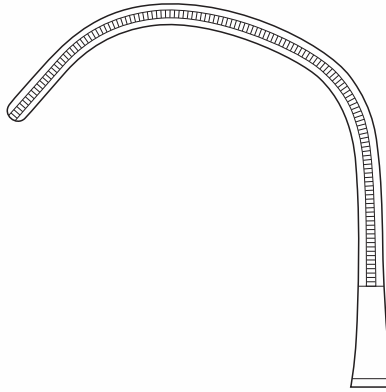

CV6030-21



Weber Aortic Clamp

- 26cm/10 1/4" length

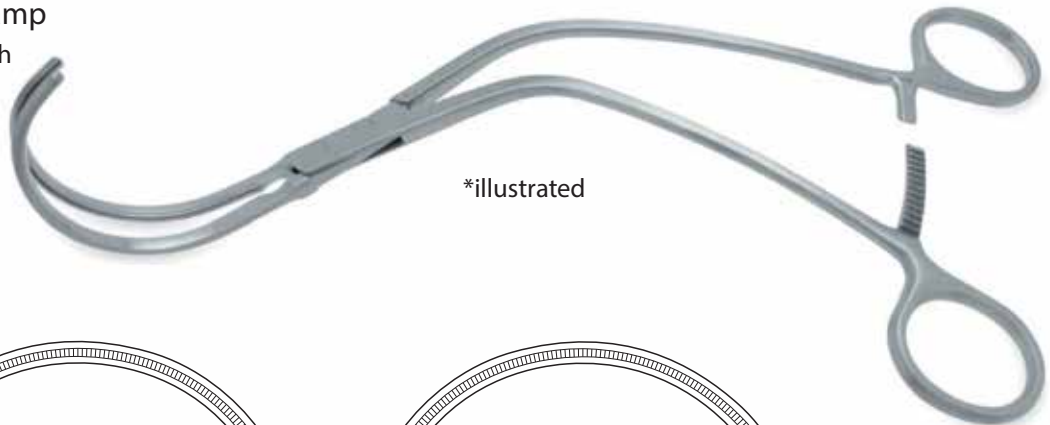

*illustrated

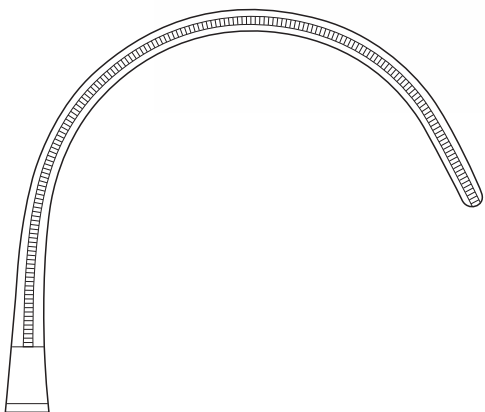

CV6031-26 * Left curved

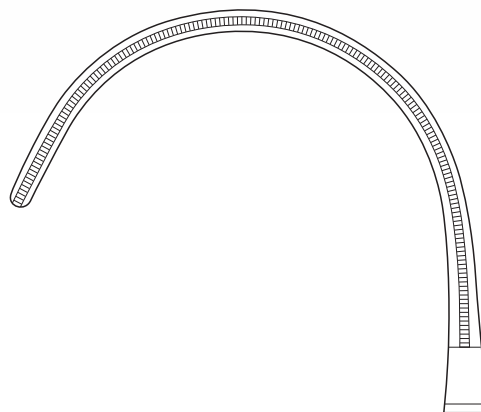

CV6032-26 Right curved



VASCULAR CLAMPS

DeBakey Aortic Aneurism Clamp

- Curved Shanks

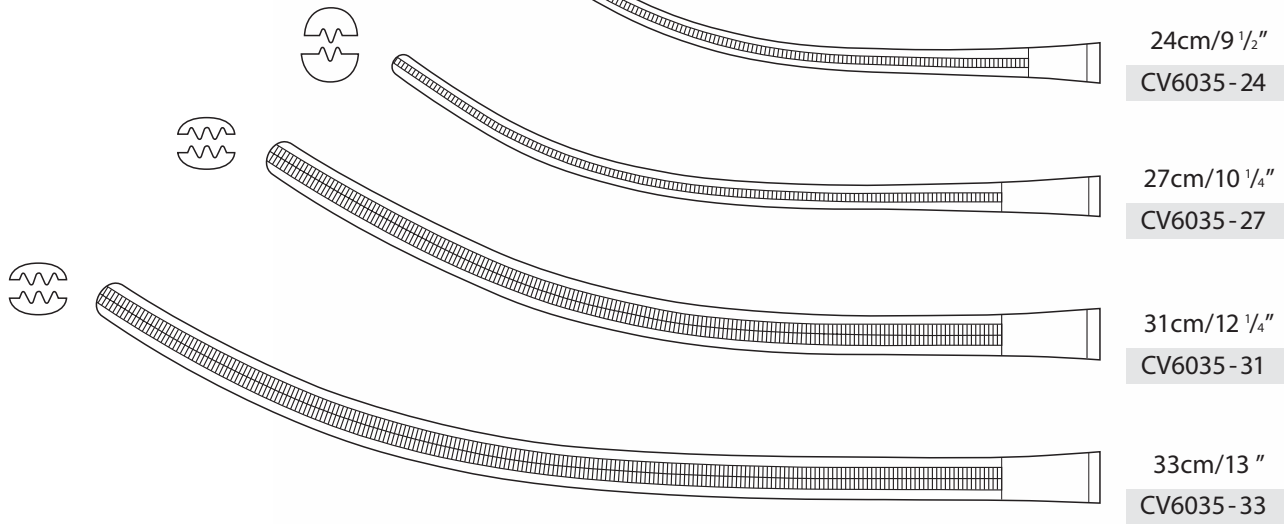

DeBakey-Bahnson Aortic Aneurism Clamp

- S-Shape Shanks

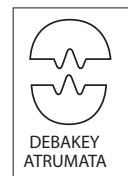
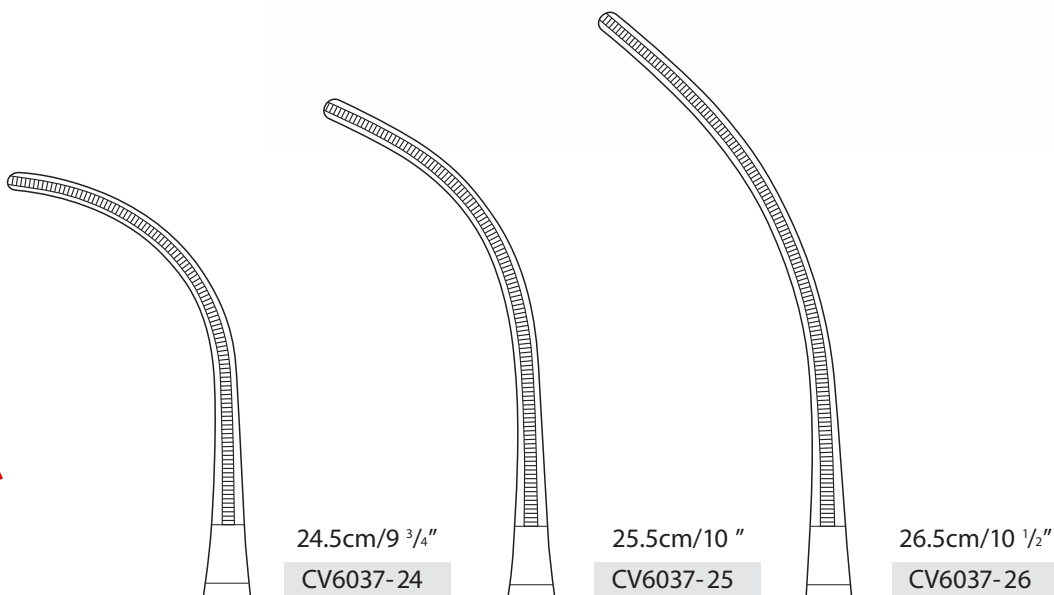

VASCULAR CLAMPS

DeBakey Glover Patent Ductus Clamp

- Straight Shanks

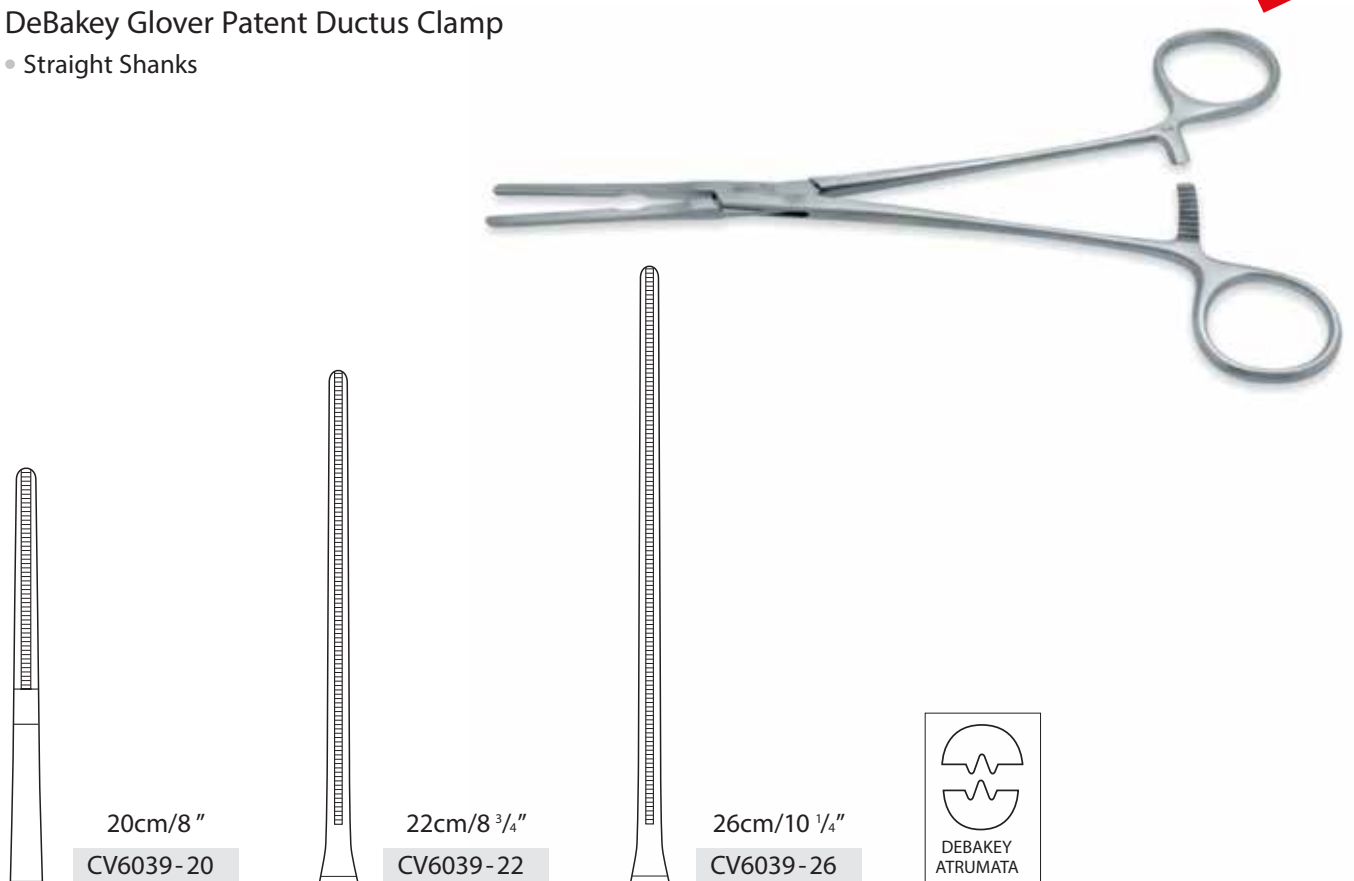

DeBakey Glover Patent Ductus Clamp

- Angled Shanks

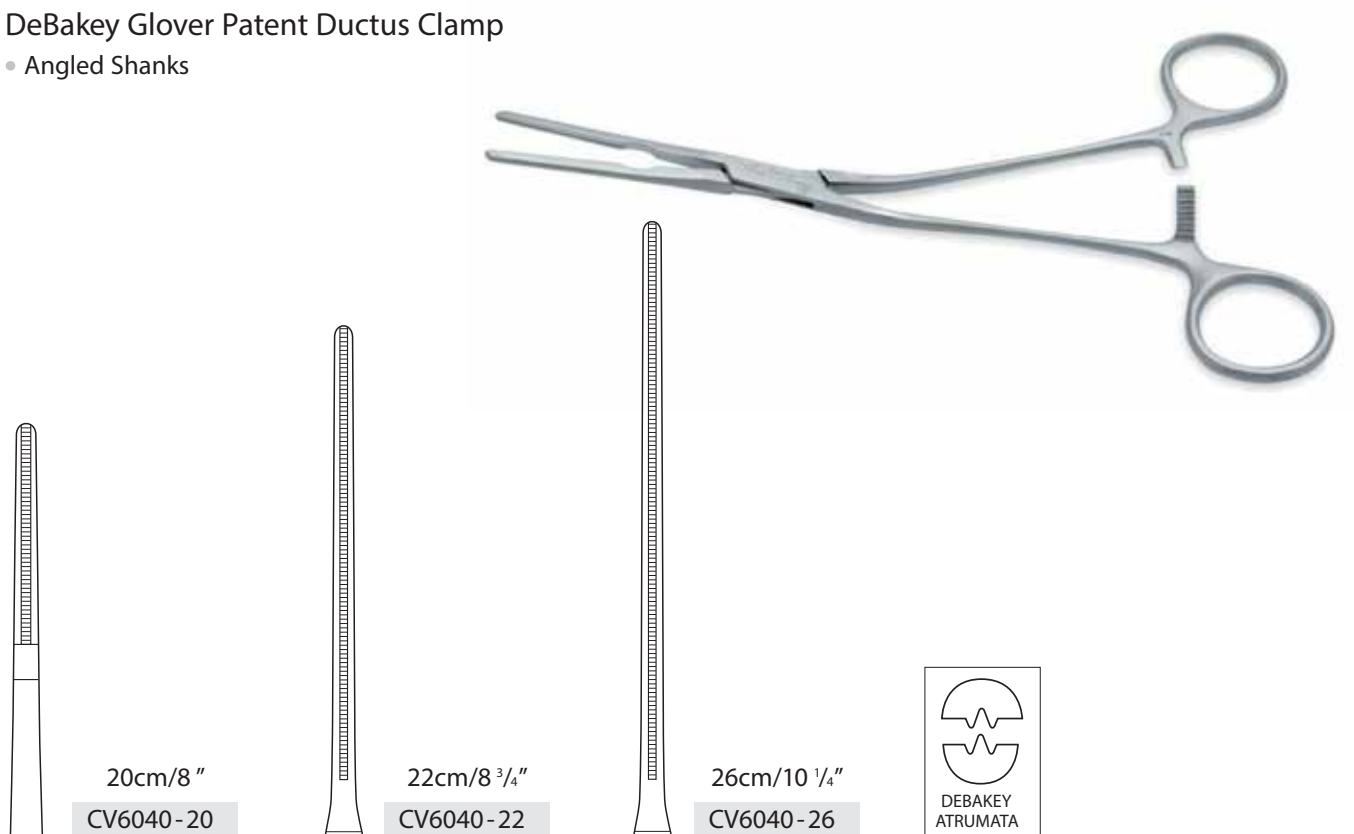

VASCULAR CLAMPS

DeBakey Peripheral Clamp



*illustrated

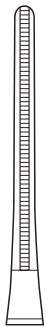

Straight Shanks *
19.5cm/7 3/4"

CV6042-19

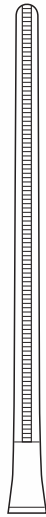

Straight Shanks
22cm/8 3/4"

CV6042-22

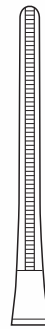

Angled Shanks
19.5cm/7 3/4"

CV6044-19



Angled Shanks
22cm/8 3/4"

CV6044-22



DeBakey Peripheral Clamp

- Curved Shanks
- Angled 45°

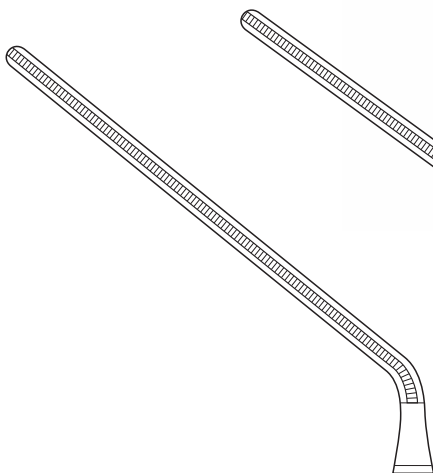

19cm/7 1/2"

CV6045-19

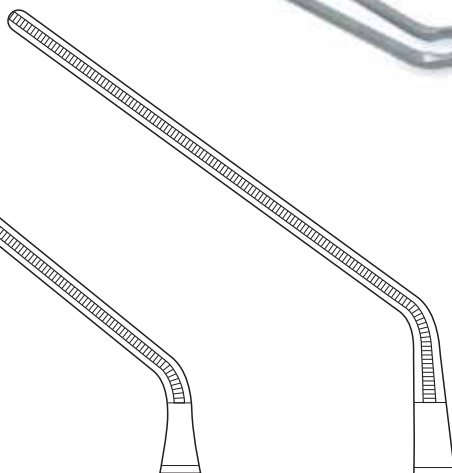

26cm/8 1/2"

CV6045-26

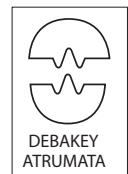

VASCULAR CLAMPS

DeBakey Peripheral Clamp

- S- Shaped

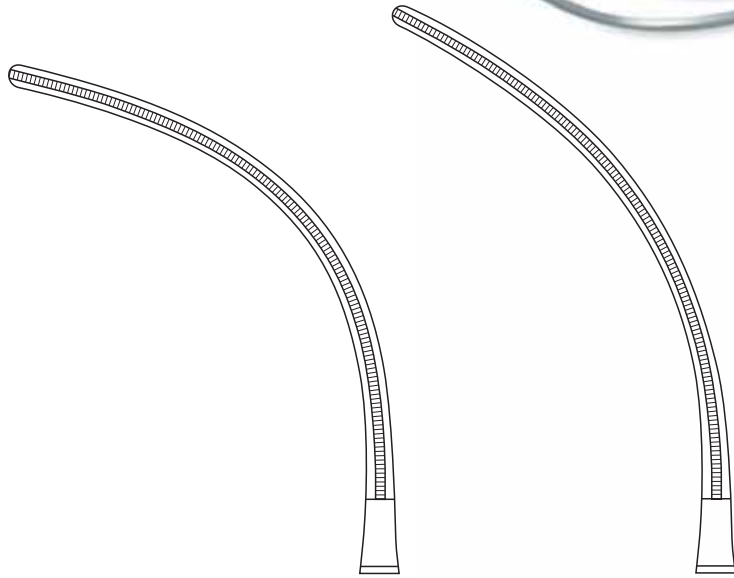

19cm/7 1/2" *
CV6046-19

20cm/8" *
CV6046-20

*illustrated



Leland-Jones Peripheral Vascular Clamp

- Straight Shanks

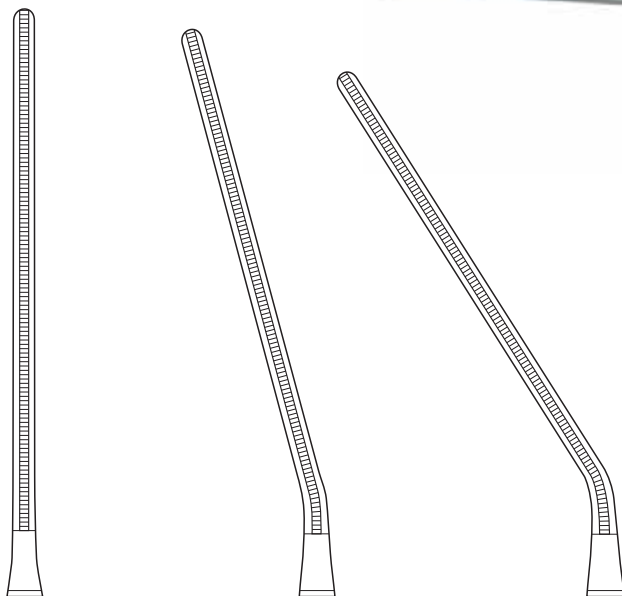

19cm/7 1/2"
CV6048-19

20cm/8" *
CV6049-20

19cm/7 1/2"
CV6050-19

*illustrated

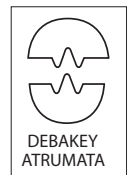
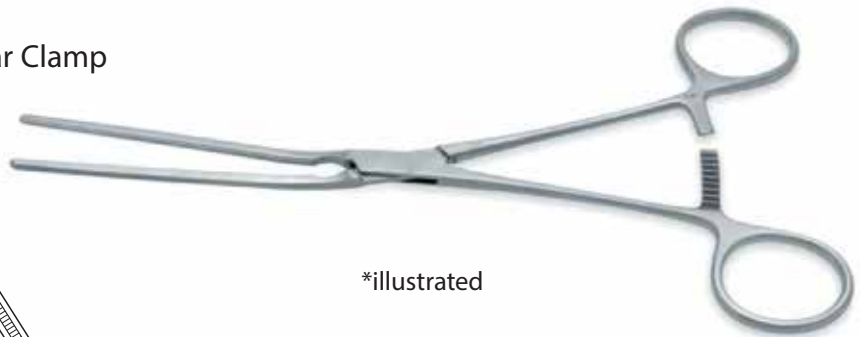

VASCULAR CLAMPS

DeBakey Multi-Purpose Clamp

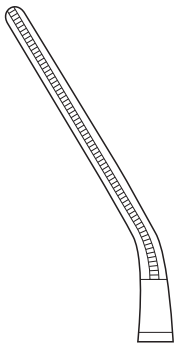

CV6055-16 *
16cm/6 1/4"
30° Angled Jaws

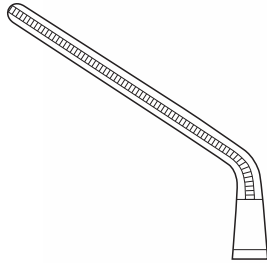

CV6055-15
15.5cm/6"
60° Angled Jaws

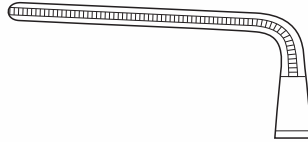

CV6055-14
14.5cm/6 1/2"
90° Angled Jaws

*illustrated



DeBakey Multi-Purpose Forceps

- Angled 60°
- Curved Shanks



*illustrated

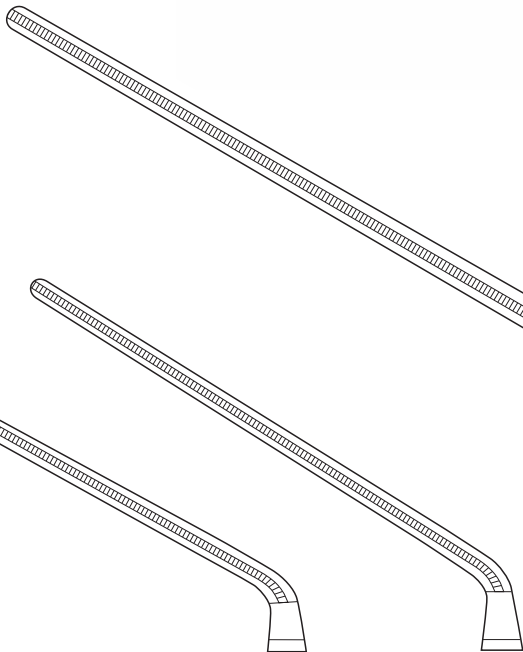

CV6052-20
20cm/8"

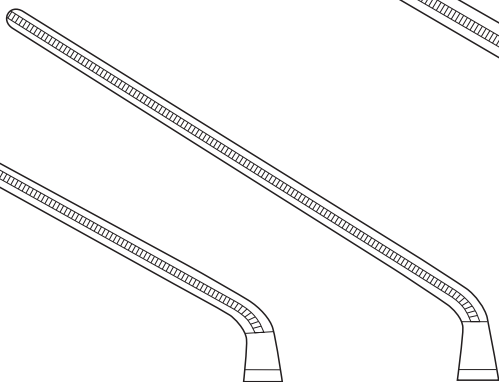

CV6052-24 *
24cm/9 1/2"

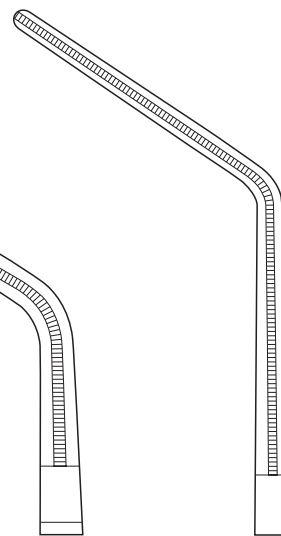

CV6052-30
30cm/12"

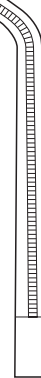

CV6052-25
25cm/10"

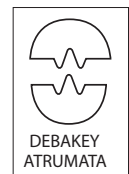

VASCULAR CLAMPS

DeBakey Multi-Purpose Clamp

- Angled 90°

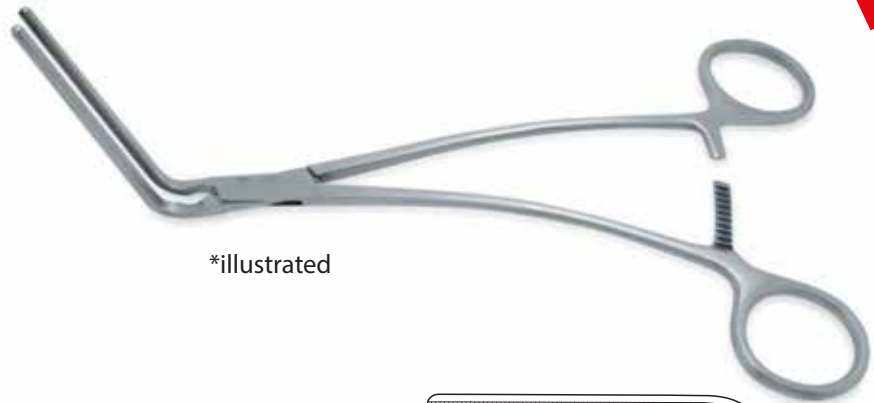

*illustrated

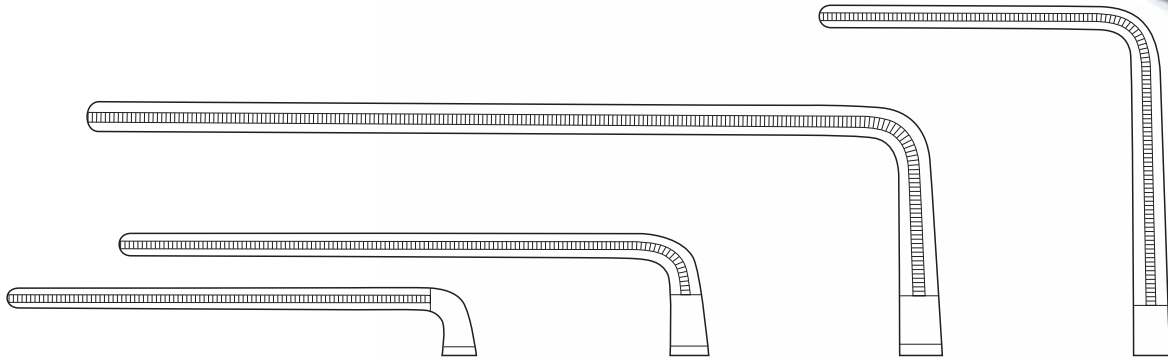

CV6054-18

18cm/7"

CV6054-21 *

21.5cm/8 1/2"

CV6054-27

27.5cm/10 3/4"

CV6054-23

23cm/9"

DeBakey-Beck Paediatric Aortic Forceps

- Straight Shanks

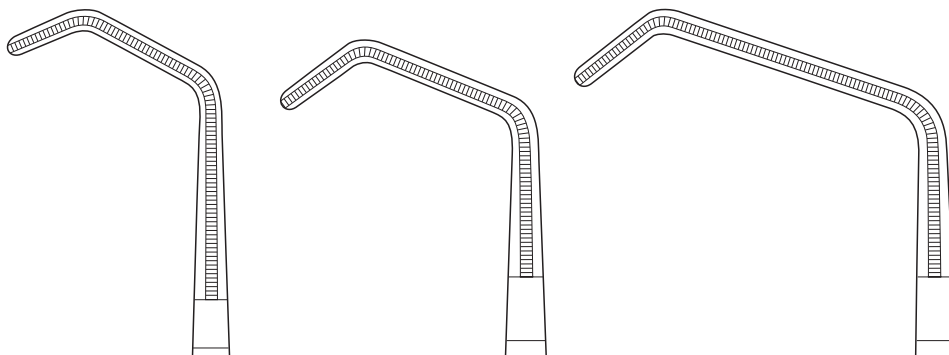

CV6057-16

16.5cm/6 1/2"
Small

CV6057-19 *

19.5cm/7 3/4"
Medium

CV6057-20

20.5cm/8"
Large

VASCULAR CLAMPS

DeBakey Tangential Occlusion Clamp

- Curved Shanks

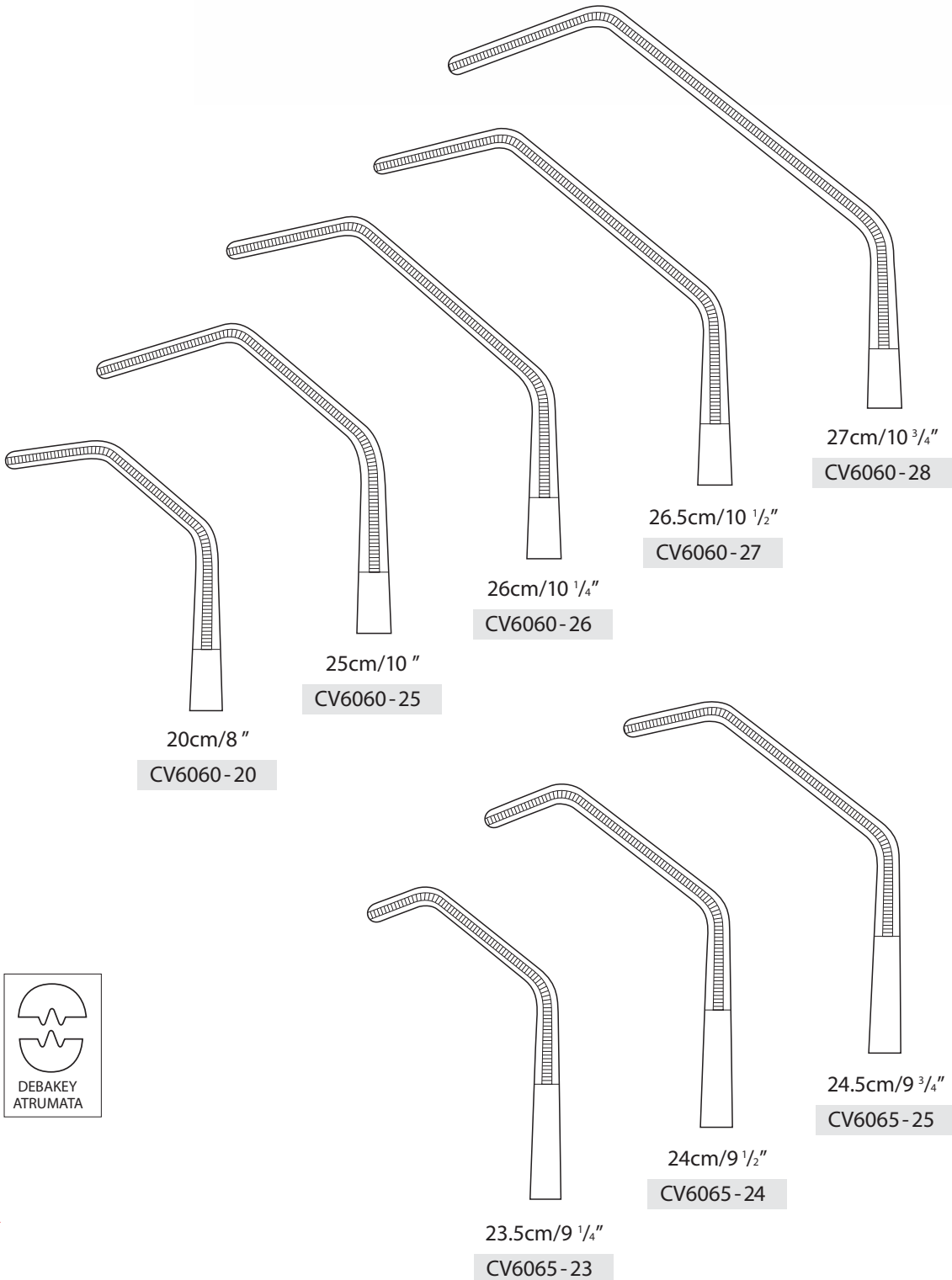
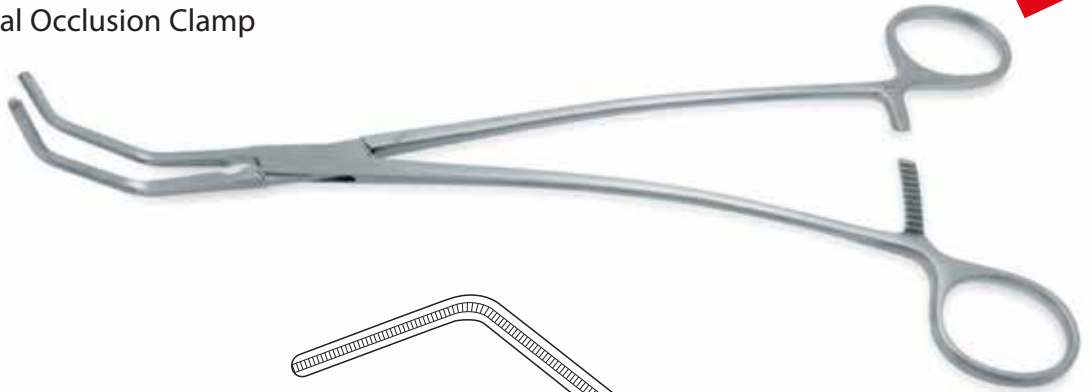

VASCULAR CLAMPS

DeBakey Anastomosis Clamp

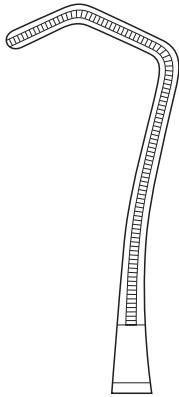

17cm/6 3/4"

MV6068-17



DeBakey-Derra Anastomosis Clamp

- 17cm/6 3/4" length

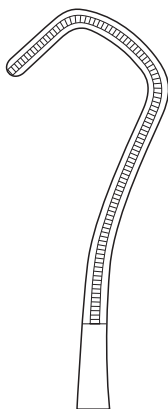

CV6070-17

Small

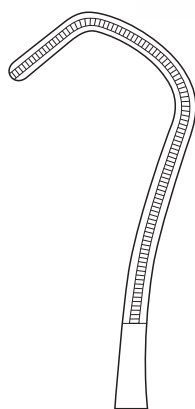

CV6071-17

Medium

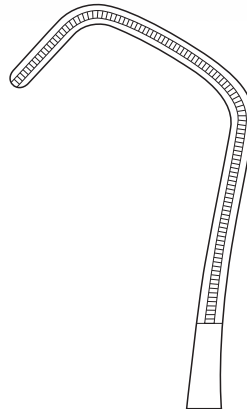

CV6072-17

Large



VASCULAR CLAMPS

DeBakey-Reynolds Anastomosis Clamp

- Angled Shanks

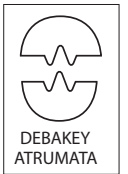
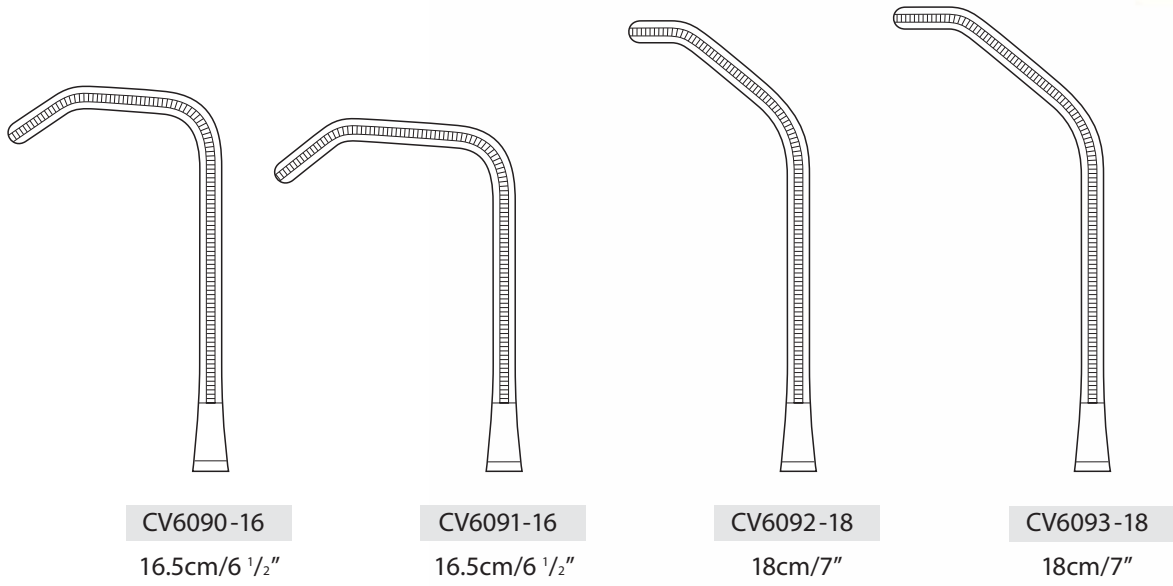

DeBakey Curved Anastomosis Forceps

- 17cm/6 3/4" length
- Curved Shanks

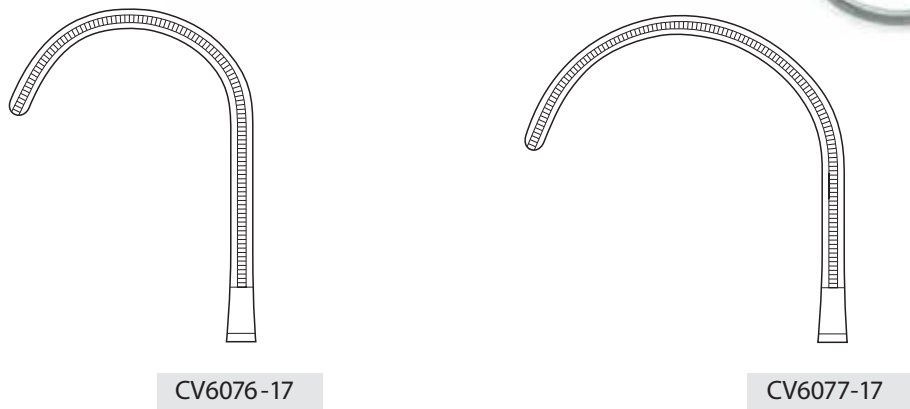

VASCULAR CLAMPS

DeBakey-Semb Ligature Carrier

- 25cm/10" length

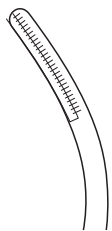

CV6104-25



DeBakey Ligature Forceps

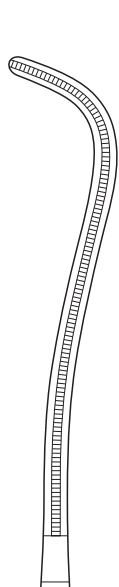

CV6107-19

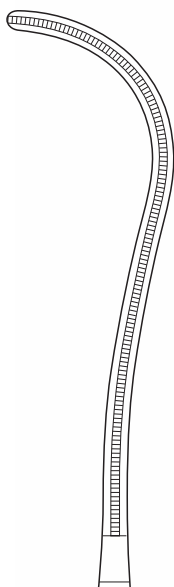

CV6108-19



Semb Ligature Forceps

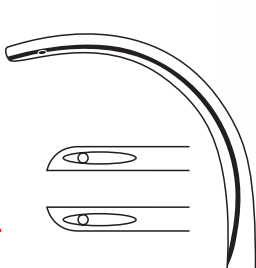

CV6110-23



CV6111-24



VASCULAR CLAMPS

Cooley-Derra Anastomosis Clamp

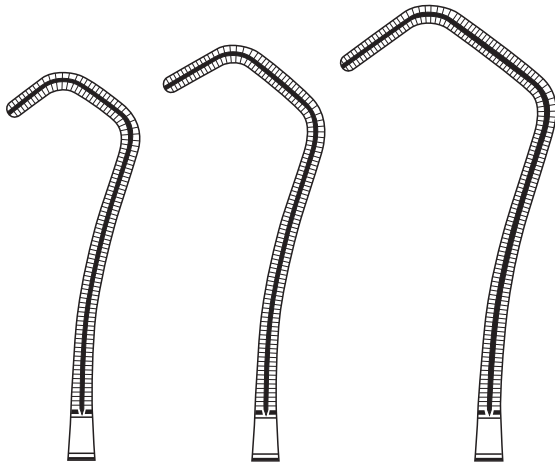

CV6115-16

small
16.5cm/6 1/2"

CV6116-17

medium
17cm/6 3/4"

CV6117-17

large
17.5cm/7"



Cooley-Beck Vascular Clamp

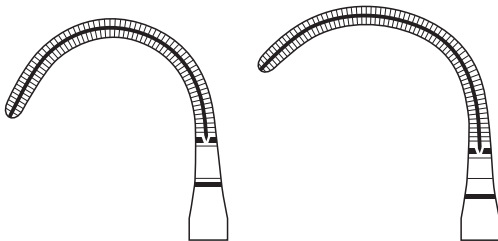

CV6120-15

15cm/6"

CV6121-15

15cm/6"



Cooley Coarctation Clamp

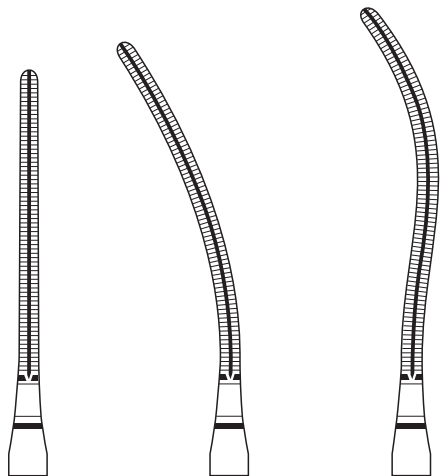

CV6140-17

17cm/6 3/4"

CV6141-17

17cm/6 3/4"

CV6142-18

18cm/7"

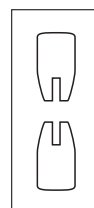

VASCULAR CLAMPS

Javid Carotid Clamp

- Small size
- 15cm/6" length

CV6200-15



For holding the shunt tube during Carotid Surgery

Javid Carotid Clamp

- Large size
- 18cm/7" length

CV6200-18



Dardik Multi-Purpose Clamp

Jaw Angle 15cm/6" length 17cm/6 3/4" length

0°	CV6125-00	CV6130-00
15°	CV6125-15	CV6130-15
30°	CV6125-30	CV6130-30
45°	CV6125-45	CV6130-45
90°	CV6125-90	CV6130-90

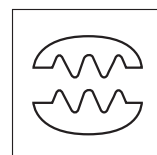
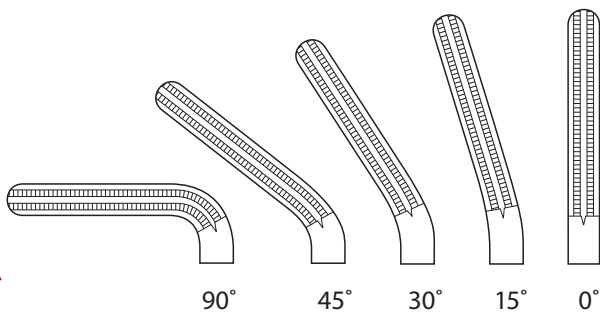

Frazier Suction Tube

- Angled 30°

diameter Ø	Overall Length	
	17cm/6 1/2"	23cm/9"
2.0mm 6FG	CP9041-17	CP9041-23
2.3mm 7FG	CP9042-17	CP9042-23
2.7mm 8FG	CP9043-17	CP9043-23
3.0mm 9FG	CP9044-17	CP9044-23
3.3mm 10FG	CP9045-17	CP9045-23
3.7mm 11FG	CP9046-17	CP9046-23
4.0mm 12FG	CP9047-17	CP9047-23



American Pattern Suction Tube

- 16.5cm/6 1/2" length

CV7402-16



Brompton Hospital Suction Tube

- 30cm/11 3/4" length



CV7406-30 Adult size for 9.5mm³/₈" tubing

CV7407-30 Child size for 6mm¹/₄" tubing

Brompton Hospital Suction Tube

- Paediatric 4.8mm Ø Tip size
- 23cm/9" length
- For 6.5mm¹/₄" tubing

CV7403-23



Southampton Western Hospital Suction Tube

- 22cm/8 1/2" length
- Paediatric 3.3mm¹/₈" Ø
- For 6.5mm¹/₄" tubing

CV7401-22



SUCTION TUBES & CANNULA

Tibbs Arterial Cannula

- Long Pattern
- Luer lock

Set of 4	CV7200-10
Large Cone	CV7200-20
Small Cone	CV7200-30
Large Olive	CV7200-40
Small Olive	CV7200-50



Heparin Flushing Needle

- Luer lock

2mm Ø Tip	CV7201-20	2.5mm Ø Tip	CV7201-25	3mm Ø Tip	CV7201-30
-----------	-----------	-------------	-----------	-----------	-----------



Magill Suction Tube

- 21cm/8 1/4" length

3mm Ø Tip	CV7401-21	3.5mm Ø Tip	CV7402-21	4.0mm Ø Tip	CV7403-21
-----------	-----------	-------------	-----------	-------------	-----------



Yankauer Suction Tube

- 30.5cm/12" length

CV7409-30



Pooles Suction Tube

- 24cm/9 1/2" length
- 10mm Ø

CV7405-24	Straight mount *illustrated
CV7406-24	Curved mount



Paediatric Pooles Suction Tube

- 15cm/6" length
- 6mm Ø

CV7405-15



PERFUSION CANNULA

Ross Atrial Basket



length	tubing size Ø	code
29mm	1/2"/12.7mm	CV7205-15
29mm	3/8"/9.5mm	CV7205-20
19mm	3/8"/9.5mm	CV7205-25
16mm	1/4"/6.3mm	CV7205-30

Ross Sump Sucker (screw apart)



	diameter	tubing size Ø	code
Adult	7.5mm	3/16"/5.0mm	CV7206-75
Child	6.5mm	3/16"/5.0mm	CV7206-65
Infant	5.0mm	1/8"/3.5mm	CV7206-50

Ross Ventricular Vent (screw apart)



	diameter	tubing size Ø	code
Adult	7.5mm	3/16"/5.0mm	CV7207-75
Child	6.5mm	3/16"/5.0mm	CV7207-65
Infant	5.0mm	1/8"/3.5mm	CV7207-50

Baylor Sump Sucker (screw apart)



outside diameter	45° angled	90° angled
4.0mm	CV7208-40	CV7209-40
5.0mm	CV7208-50	CV7209-50
6.0mm	CV7208-60	CV7209-60

Bentall Femoral Cannula

- Rolled edge to bevel



bore Ø	code	bore Ø	code
1.5mm	CV7210-15	4.5mm	CV7210-45
2.0mm	CV7210-20	5.0mm	CV7210-50
2.5mm	CV7210-25	5.5mm	CV7210-55
3.0mm	CV7210-30	6.0mm	CV7210-60
3.5mm	CV7210-35	6.5mm	CV7210-65
4.0mm	CV7210-40	7.0mm	CV7210-70

Iliac Cannula

- Angled



bore Ø	code	bore Ø	code
2.5mm	CV7211-25	4.5mm	CV7211-45
3.0mm	CV7211-30	5.0mm	CV7211-50
3.5mm	CV7211-35	5.5mm	CV7211-55
4.0mm	CV7211-40	6.0mm	CV7211-60

JS Venous Cannula

- Cage tip
- 80° angled
- Long tubing end



bore Ø	code	bore Ø	code
3mm	CV7212-30	6mm	CV7212-60
4mm	CV7212-40	7mm	CV7212-70
5mm	CV7212-50	8mm	CV7212-80

Ross Coronary Artery Probe

- Same thickness along length of shaft

diameter Ø 10cm length 15cm length

0.5mm	CV7301-05	CV7302-05
1.0mm	CV7301-10	CV7302-10
1.5mm	CV7301-15	CV7302-15
2.0mm	CV7301-20	CV7302-20
2.5mm	CV7301-25	CV7302-25
3.0mm	CV7301-30	CV7302-30



DeBakey Vessel Dilator

- 190mm length
- Malleable shaft

diameter Ø

0.5mm	CV7303-05
1.0mm	CV7303-10
1.5mm	CV7303-15
2.0mm	CV7303-20
2.5mm	CV7303-25
3.0mm	CV7303-30

diameter Ø

3.5mm	CV7303-35
4.0mm	CV7303-40
4.5mm	CV7303-45
5.0mm	CV7303-50
7.0mm	CV7303-70
9.0mm	CV7303-90



Garrett Vessel Dilator

- Malleable shaft

diameter Ø 14cm length

1.0mm	CV7304-10
1.5mm	CV7304-15
2.0mm	CV7304-20
2.5mm	CV7304-25
3.0mm	CV7304-30
3.5mm	CV7304-35
4.0mm	CV7304-40
4.5mm	CV7304-45
5.0mm	CV7304-50

diameter Ø 21cm length

1.0mm	CV7305-10
1.5mm	CV7305-15
2.0mm	CV7305-20
2.5mm	CV7305-25
3.0mm	CV7305-30
3.5mm	CV7305-35
4.0mm	CV7305-40
4.5mm	CV7305-45
5.0mm	CV7305-50





SINGLE TRAY CONTAINERS

Internal Dimensions			Code
A	B	C	
200	140	50mm	E 4026/1
280	195	50mm	E 4026/4
265	255	50mm	E 4026/5
380	260	50mm	E 4026/7

E 4026/5

Standard Container illustrated

One of our popular cases for Micro Instruments



DOUBLE TRAY CONTAINERS

Internal Dimensions			Code
A	B	C	
280	195	65mm	E 4026/4 D
265	255	65mm	E 4026/5 D
380	260	65mm	E 4026/7 D

E 4026/5D

Double Tray Container illustrated

Two take-out perforated plates

Rummel Cardiac Stilette

- Suture Hook
- 32.5cm length



CV7008-32

Diamond Knife

- Titanium Handle with retractable blade
- 1mm x 6mm blade
- For neuro or cardiac surgery



CV7001-00

Stainless Steel Measuring Ruler

Code	Length
CA5005-15	15cm/6"
CA5005-30	30cm/12"



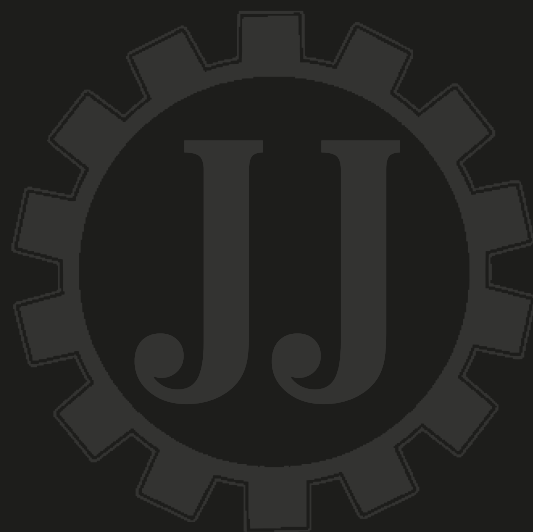

International Instruments

Designers & Manufacturers of Surgical Instruments

Corporate Office & Factory

337/N, Amala Antonian Plaza
Kinfra Park P.O., Thrissur (Dt.)
Kerala State, India - 680 309
Tel : +91 480 273 5959 / 5858

USA Office

12916 Edsel Dr.
Raleigh NC 27613
USA
Tel : +1 919 467 5278

Middle East Office

211 Bait Al Ali Building
Al-Khuwair, Muscat
Oman
Tel : +968 99053791

sales@myjjonline.com, myjjonline@yahoo.com

www.myjjonline.com