

ORTHOPAEDIC INSTRUMENTS



International Instruments
Designers & Manufacturers of Surgical Instruments



International Instruments

Designers & Manufacturers of Surgical Instruments

ABOUT US

JJ International Instruments is a leader in manufacturing surgical instruments in India. JJ designs & manufactures high quality stainless steel surgical instruments in south Indian state, Kerala – The renowned 'God's Own Country' since 1996. JJ distributes their instruments all over India and export to Middle East and USA.

CONTINUES SUCCESS!

'JJ' has introduced their products in USA market by exhibiting during AAOS 2013 in Chicago with tremendous response from both domestic and international surgeons. JJ now participates atleast 5-7 tradeshows in USA and more than 20 tradeshows in India yearly. JJ is the only one company in India who has approved by US FDA.

Certified by

US FDA,
CE & ISO

**INTERNATIONAL
QUALITY @ INDIAN
PRICE !!**

www.myjjonline.com

US FDA Reg No. 3010077069

CE Reg No. DCS/943962

ISO Reg No. QACS-A-0623

JJ design & manufacture complete Surgical Instruments for -

General Orthopaedic, Spine, Hand & Micro Surgery, Gynec & Obstetrics, Uro, E.N.T, Neuro, Thoracic & Cardiovascular, Plastic, General surgery.

Features and Benefits

- Genuine JJ Brand
- Made out of German Stainless Steel SS410
- International Quality & Specifications.
- 5 Warranty against manufacturing defect
- Life time warranty against material defect
- Absolutely competitive price
- JJ welcomes new ideas and designs

JJ's repairing & refurbishing program:

- Repairing & refurbishing of surgical instrument of any brand
- Reduce purchase budget drastically
- Repairing and servicing with limited warranty
- Annual Maintenance Contract (AMC) offered
- Free service for the first batch of instruments

JJ's Mobile Trade Expo

- Introducing mobile sales and service all over India
- Specially designed instruments for selection
- Easy to select, exchange and experience the instrument
- Get technical advice for the instrument to be repaired

Corporate office and factory:

357/N, Amala Antonian Plaza

Kinfra Park P.O., Kerala, India - 680309

+91 480 2735959, +91 94970 77555, +91 98465 86556

USA Sales Office:

1000 Center Green Way, Cary NC 27513 USA. +1 919 4675278

Middle East Sales office

No. E-74G-35, Hamriyah Free Zone, Sharjah, UAE. +971 50 7571358

Middle East office & Service Center

Suite 221, Bait Al Ali Bldg, Al-Khuwair, Muscat, Oman +968 99053791

Sales@myjjonline.com, info@myjjonline.com

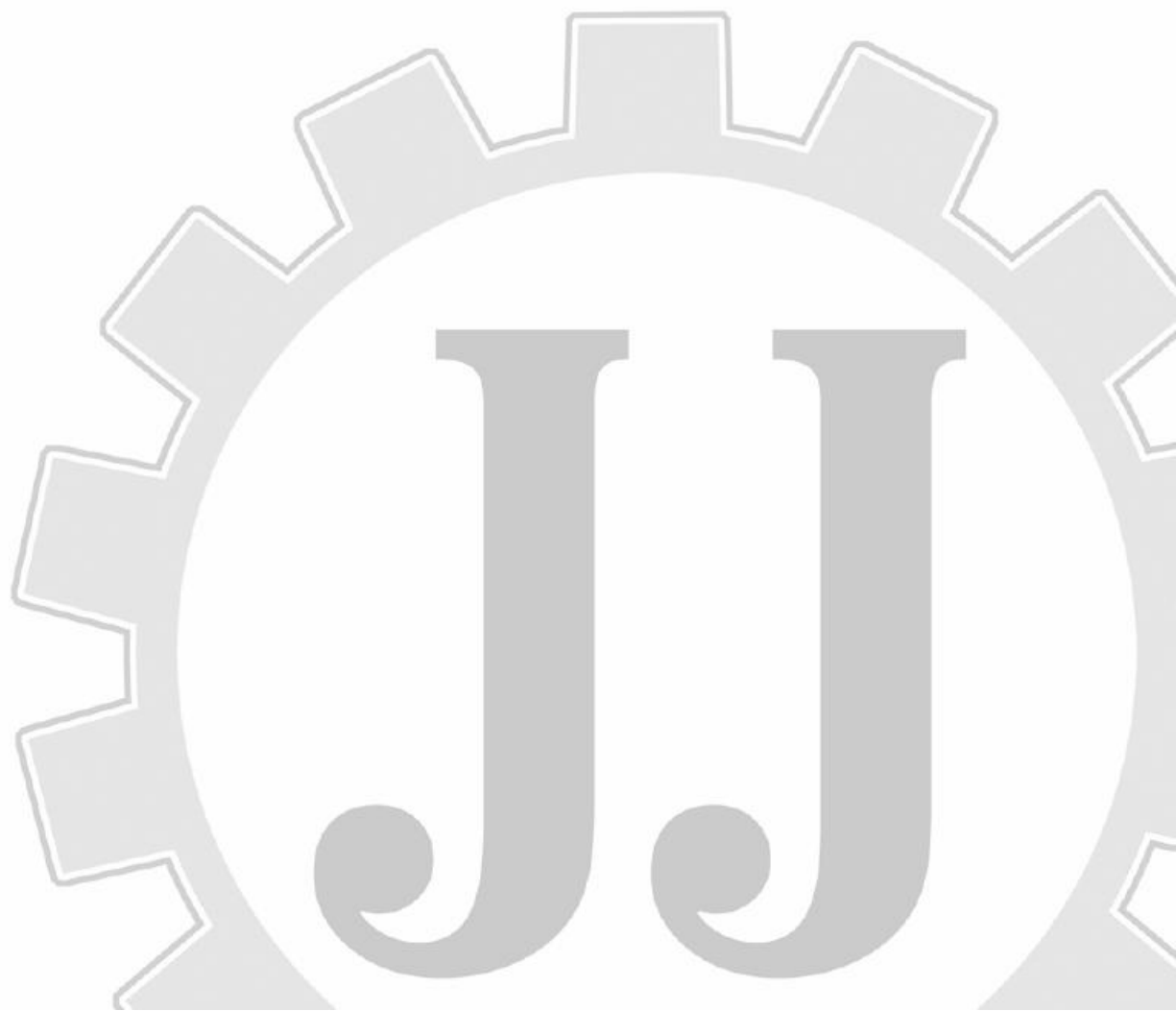

Contents**Pages**

ELEVATORS.....	1- 6
BONE HOOK.....	7
BONE SPREADERS.....	8
BONE CUTTERS.....	9
BONE NIBLERS.....	10-12
BONE HOLDING FORCEPS.....	13-14
PELVIC REDUCTION.....	15-16
RETRACTORS.....	17-22
MALLETS.....	23-24
OSTEOTOMES& GOUGES.....	25-28
BONE CURETTES.....	29
REVITON INSTRUMENTS.....	30-35
HIP JOINT INSTRUMENTS.....	36
PLIERS & WIRE CUTTERS.....	37-39
LOCKING PLIERS.....	40
PIN INTRODUCERS.....	41
BONE MILL WIRE PASSERS.....	42
SCREW DRIVERS.....	43-44
DISSECTORS.....	45
MEASURING INSTRUMENTS.....	46
SHOULDER SURGERY INSTRUMENTS.....	47

ELEVATORS

Adson Periosteal Elevator

- 16cm/6¼" length
- Curved blunt

	Width
OR 3052-16	2 mm
OR 3055-16	5 mm
OR 3007-16	7 mm
OR 3054-16	4 mm



Pennybacker Periosteal Elevator

- 16cm/6¼" length
- Curved sharp

	Width
OR3064-16	4mm
OR3066-16	6mm
OR3068-16	8mm



Bone Raspatory with Tufnol Handle

- 19cm/7½" length

Straight	Width
OR7016-19	6mm
Conical Straight	
OR 7015-14	

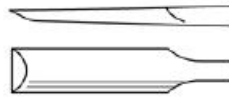

Curved	Width
OR7023-19	3mm
OR7026-19	6mm
Conical Curved	
OR 7015-14	

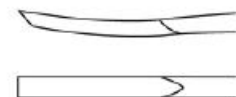

Farabeuf Rugine Elevator

- 15cm/6" length

Straight	Width
OR 3001-15	12 mm
OR 3001-05	5 mm
Curved*	Width
OR 3002-15	12 mm
OR 3002-05	5 mm



*illustrated

Farabeuf Rugine Elevator with Hollow Handle

- 16cm/6¼" length

Straight	Width
OR3011-16	12mm
Curved*	Width
OR3012-16	12mm



*illustrated

Key Elevator

- 18cm/7" length

OR 874	6 mm
OR 875	12 mm
OR 876	19 mm
OR 877	25 mm



ELEVATORS

Trethowan Bone Elevator

- 22.5cm/8½" length

OR3030-22



Lanes Bone Elevator

- 26cm/10" length

OR3031-26



Fagge Bone Elevator

- 27.5cm/10¾" length

OR3032-27



Bristow Periosteal Elevator

- 23cm/9" length
- Curved sharp
- 10mm width

OR 3003-10

- 15mm width

OR 3003-15



Femoral Dislocation Lever

- 31cm/12½" length
- 26mm width

OR3026-31



Muller Femoral Retractor

- 35cm/13½" length
- 28mm width

OR3028-35



For retraction of the femoral neck.

MINI ELEVATORS

Mini Bone Lever

- 14cm/5½"
- 2.8mm width

OR5830-14



Hohmann Style Mini-Bone Lever

- 16cm/6¼"
- 6mm width

OR5831-16



Phalangeal Lever

- 15cm/6"
- 5mm width

OR5832-16



Buck-Gramcko Lever

- 15cm/6"
- 7.5mm width

OR5833-15



Mini-Cobra Bone Lever

- 16cm/6¼"
- 15mm width

OR5834-16



McGlamry Metatarsal Elevator

- 17cm/6½"
- Sharp

Width

OR5835-10	9mm
OR5835-12	11mm
OR5835-14	13mm
OR5835-16	15mm
OR5835-19	19mm



ELEVATORS

Hohmann Bone Elevator

- 22cm/8½" length

width

OR 3009-08	8 mm
OR 3009-10	10 mm
OR 3009-15	15 mm



Hohmann Bone Elevator

- 24cm/9½" length

width

OR 3018-17	17 mm
OR 3018-22	22 mm



Hohmann Bone Elevator

- 24cm/9½" length

width

OR 3043-33	33 mm
OR 3043-35	35 mm
OR 3043-44	44 mm

- 28cm/ 11" length

width

OR 3033-33	33 mm
OR 3033-44	44 mm



Hohmann Large Bone Elevator

- 24cm/9½" length
- 70mm width

OR 3012-70



Hohmann Bone Elevator **Blunt**

- 28cm/11" length
- 35 mm width

OR 3033-35



Hohmann Bone Elevator

- 26cm/10" length
- 24mm width

OR3024-24



ELEVATORS

Long Curved Hohmann Inferior Hip Elevator

- 40cm/16" length
- 22mm width

OR3022-40

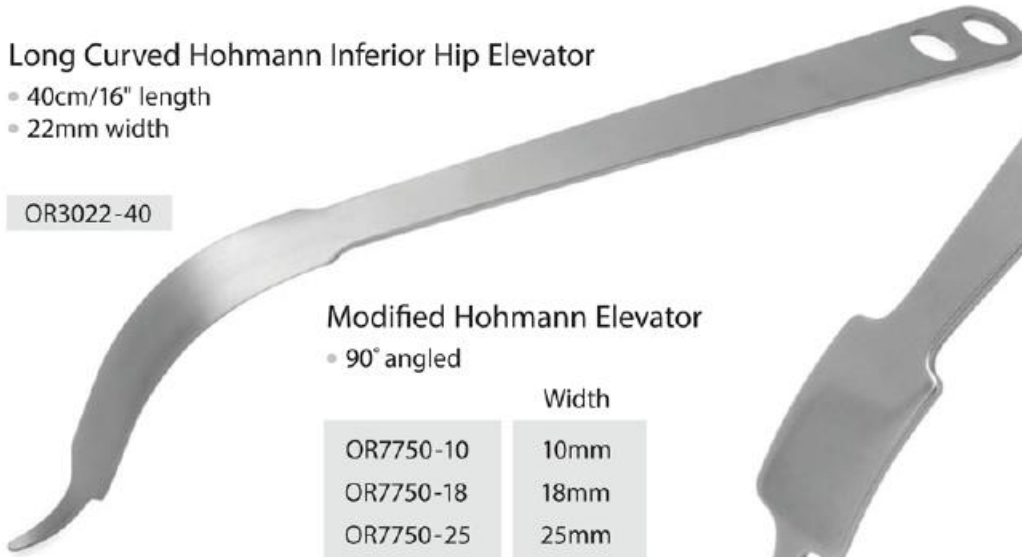

Modified Hohmann Elevator

- 90° angled

Width

OR7750-10	10mm
OR7750-18	18mm
OR7750-25	25mm
OR7750-43	43mm
OR7750-70	70mm



Modified Cobra Aufrang Elevator

- 33cm/13" long blade
- 30mm x 100mm

OR7742-10



Shallow Bone Elevator

- 25cm/9¾" length

OR7755-25

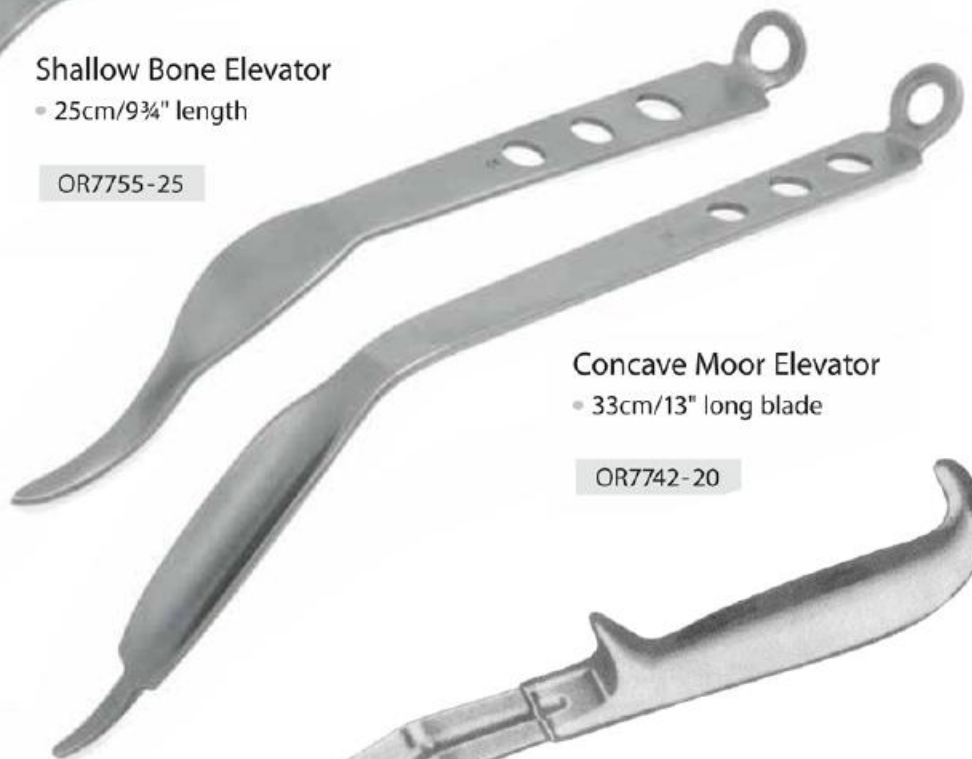

Concave Moor Elevator

- 33cm/13" long blade

OR7742-20



Bennet Elevator

- 25cm/10" length

OR 3080-40

ELEVATORS

Murphy Bone Skid Elevator

- 28cm/11" length
- For dislocation of the femoral head
- Double ended

OR0589-23



Infero-Posterior Acetabular Capsule Retractor

- 35cm/14" length

Right

OR7772-10

Left

OR7772-20

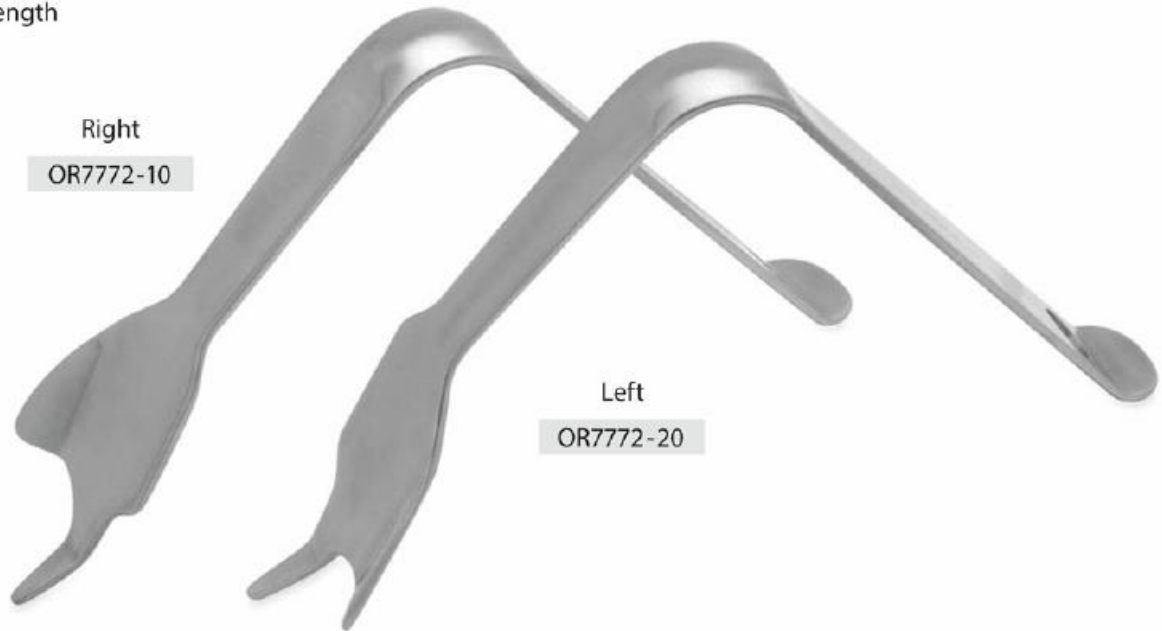

PCL Retractor

- 25cm/10" length
- To straddle the cruciate ligament
- 4mm wide prongs
- 21mm wide tips

OR7761-10



Wide Prong PCL Retractor

- 25cm/10" length
- To straddle the cruciate ligamen
- 5mm wide prongs
- 23mm wide tips

OR7762-10



BONE HOOKS

Bone Hook Sharp

- 24.5cm/9¾" length
- Sharp

OR9050-24



Blunt Hook

- 20cm/8" length

OR9051-20



Wroblenski Dislocating Hook

- 25cm/10" length
- For hooking around the neck of the Femur

OR9055-25



BONE SPREADERS

Scaphoid Spreader - Fine Pattern

- 14cm/5½" length
- 1 x 2 prongs

6mm

OR5131-14



Scaphoid Spreader - Standard Pattern

- 14cm/5½" length

6mm

OR5134-14



Baby Inge Bone Spreader

- 18cm/7" length

7mm
Toothed



OR5134-18

7mm
Smooth



OR5134-18S

7mm
Cross Serrated



OR5134-18X



Femoral Tibial Spreader

- 24cm/9 1/2"

OR 2020-24

- 20cm/8"

OR 2020-20



BONE CUTTERS

Bohler Bone Cutters

- 15cm/6" length
- Double action

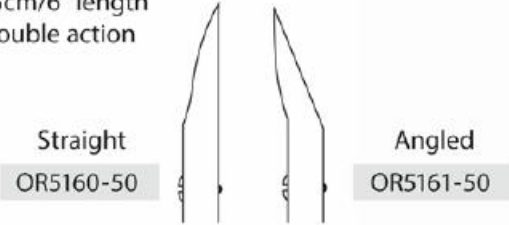

McIndoe Bone Cutters

- 18cm/7" length
- Double action
- Angled jaws

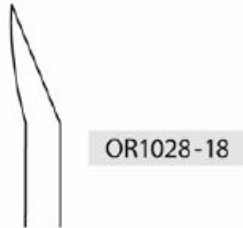

Ruskin-Liston Bone Cutters

- 19cm/7½" length
- Double action

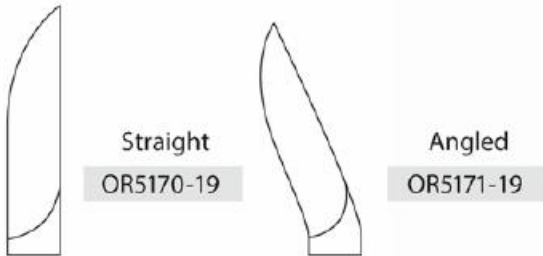

Stille-Liston Bone Cutters

- 27cm/10¾" length
- Double action

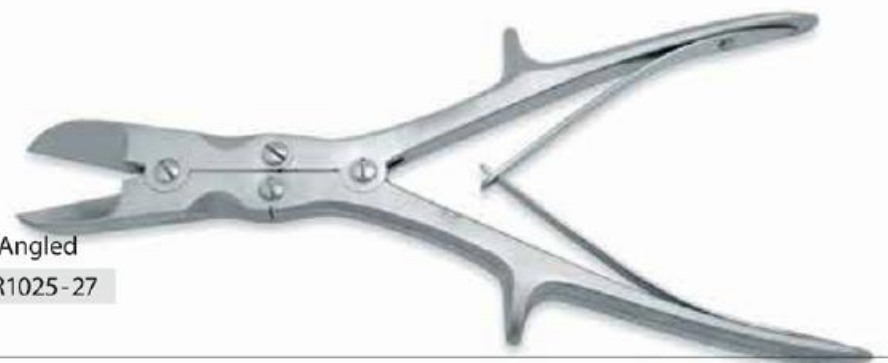
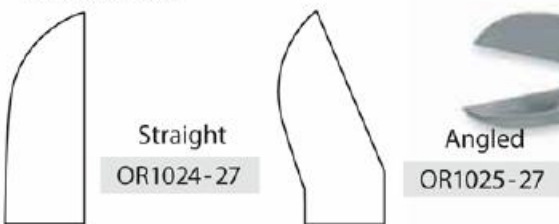

Liston-Key-Horsley Bone Cutters

- 27cm/10¾" length
- Double action
- Angled



BONE NIBBLERS

Kleinert-Kutz Bone Nibbler

- ▣ 14cm/4½" length
- ▣ Curved

2mm Bite

OR5118-50



Lempert Bone Nibbler

- ▣ 19cm/7½" length
- ▣ Single action

3mm Bite

OR1001-19



Luer Bone Nibbler

- ▣ 18cm/7" length
- ▣ Single action

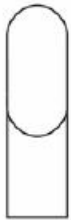

Straight
8mm Bite

OR1004-18



Curved
8mm Bite

OR1005-18



Adsons Bone Nibbler

- ▣ 20cm/8" length
- ▣ Single action



7mm Bite

OR1040-20



BONE NIBBLERS

Bohler Bone Nibbler

- Curved double action
- 15cm/6"

3mm Bite

OR5120-50



Marquardt Bone Nibbler

- 20cm/8" length
- Curved double action

3mm Bite

OR1002-20



Beyer Bone Nibbler

- Curved double action
- 18cm/7"

4mm Bite

OR1002-18



20cm/8" curved

OR1001-20

20cm/8" straight

OR1002-20

Jansen Bone Nibbler

- Curved double action
- 18cm/7"

5mm Bite

OR1003-18



18cm/7" Straight

OR1103-18

BONE NIBBLERS

Smith-Peterson Bone Nibbler

- 24cm/9½" length
- Double action

Straight	Light Curve	Bite Size
OR1010-24	OR1014-24	3mm
OR1011-24	OR1015-24	4mm
OR1012-24	OR1016-24	5mm
OR1013-24	OR1017-24	6mm

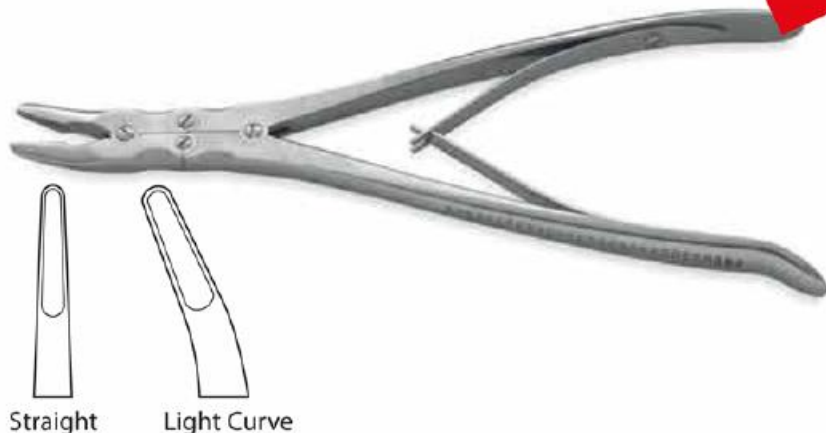

Leksell Bone Nibbler

- 24cm/9½" length
- Double action angled

Angled Jaw	Bite Size
OR1018-24	3mm
OR1019-24	5mm
OR1020-24	8mm

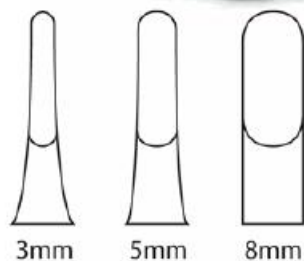

Stille-Luer Bone Nibbler

- 22cm/8¾" length
- Double action

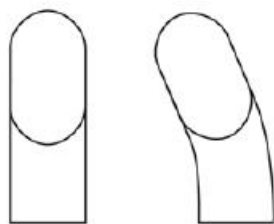

Straight 10mm Bite OR1006-22	Curved 10mm Bite OR1007-22	27cm/10 1/2" Straight OR1006-27	27cm/10 1/2" curved OR1007-27
------------------------------------	----------------------------------	------------------------------------	----------------------------------

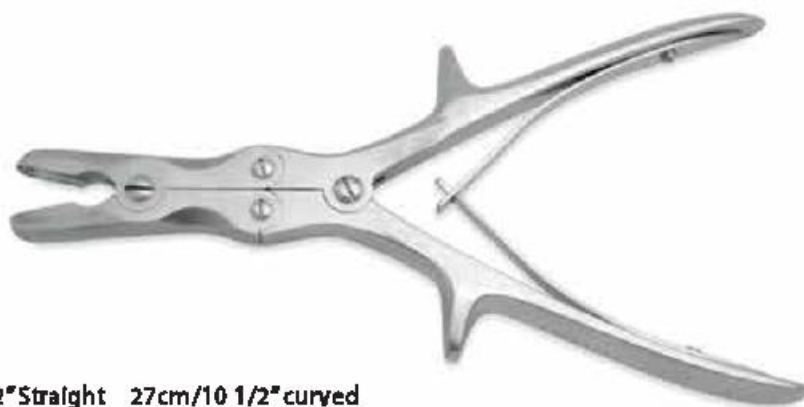

Semb Bone Nibbler

- 26cm/10¼" length
- Double action

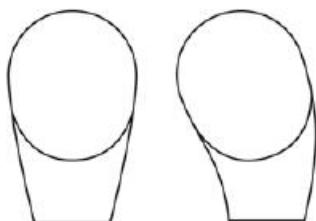

Straight 17mm Bite OR1008-26	Curved 17mm Bite OR1009-26
------------------------------------	----------------------------------



BONE HOLDING FORCEPS

Pattela Holding Forceps

- with smart lock

OR 00363



Frosch Bone Holding Forceps

- 18cm/7" length
- Toothed/serrated jaws

OR6141-18



Two Pointed Reduction Clamp

- 14cm/ 5 1/5"

HF 5042-14

- 19cm/ 7 1/5"

HF 5042-19

- 23cm/ 9"

HF 5042-23

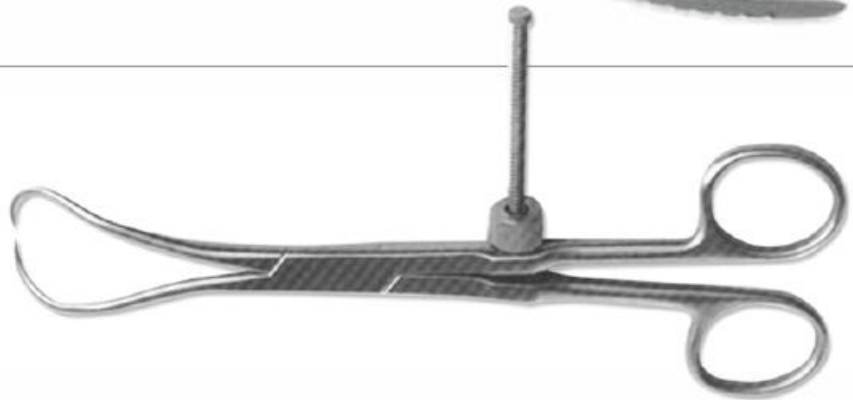

Fergusson Bone Holding Forceps

- 20cm/8" length
- Screw joint

OR6140-20



Langenbeck Bone Holding Forceps

- 21cm/8¼" length

OR6144-21



BONE HOLDING FORCEPS

Semb Bone Holding Forceps

- 19cm/7½" length
- Angled to side

OR6147-18



Hey Groves Bone Holding Forceps

- Screw joints
- Serrated jaws



Length

OR6145-20	20cm/8"	Small
OR6145-25	25.5cm/10"	Medium
OR6145-30	30.5cm/12"	Large

Verbrugge Bone Holding Forceps



Length

OR6150-25	25cm/10"	Small
OR6150-26	26cm/10½"	Medium
OR6150-27	27cm/11"	Large

Self Centering Bone Holding Forceps

OR 6149-16	16cm 6 1/2"
OR 6149-19	19cm 7 1/2"
OR 6149-22	22cm 8 1/2"
OR 6149-24	24cm 9 1/2"
OR 6149-27	27cm 10 1/2"
OR 6149-29	29cm 11 1/2"

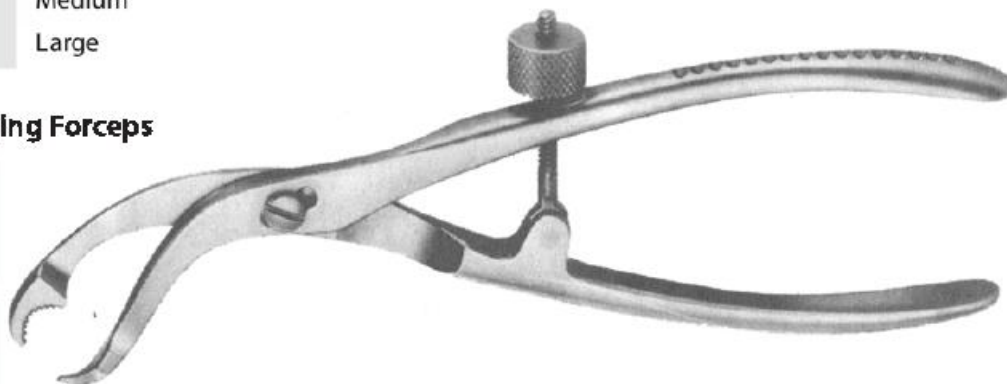

Pelvic Reduction Forceps

- 19cm/7½" length
- Angled, small
- Pointed ball tips
- Speed lock

OR6151-19



Pelvic Reduction Forceps

- 23cm/9" length
- Angled, large
- Pointed ball tips
- Speed lock

OR6152-23



Pelvic Reduction Forceps

- 25cm/10" length
- Straight, large
- Pointed ball tips
- Speed lock

OR6153-25



Pelvic Reduction Forceps

- 40cm/16" length
- Pointed ball tips
- Speed lock

OR6154-40



Pelvic Reduction Forceps

- 40cm/16" length
- 3 pointed ball tips
- Speed lock

OR6155-40



Asymmetric Pelvic Reduction Forceps

- 40cm/16" length

OR 615640

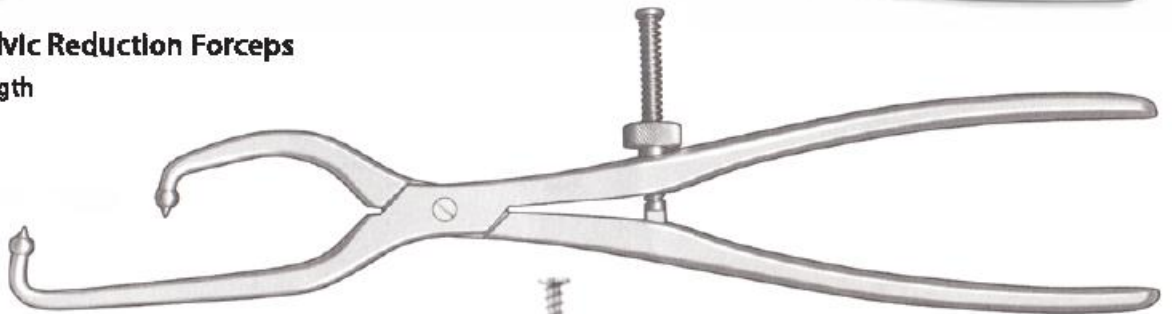

Pelvic Reduction Forceps with Screws

- 34cm/13 1/2" length

OR 615740

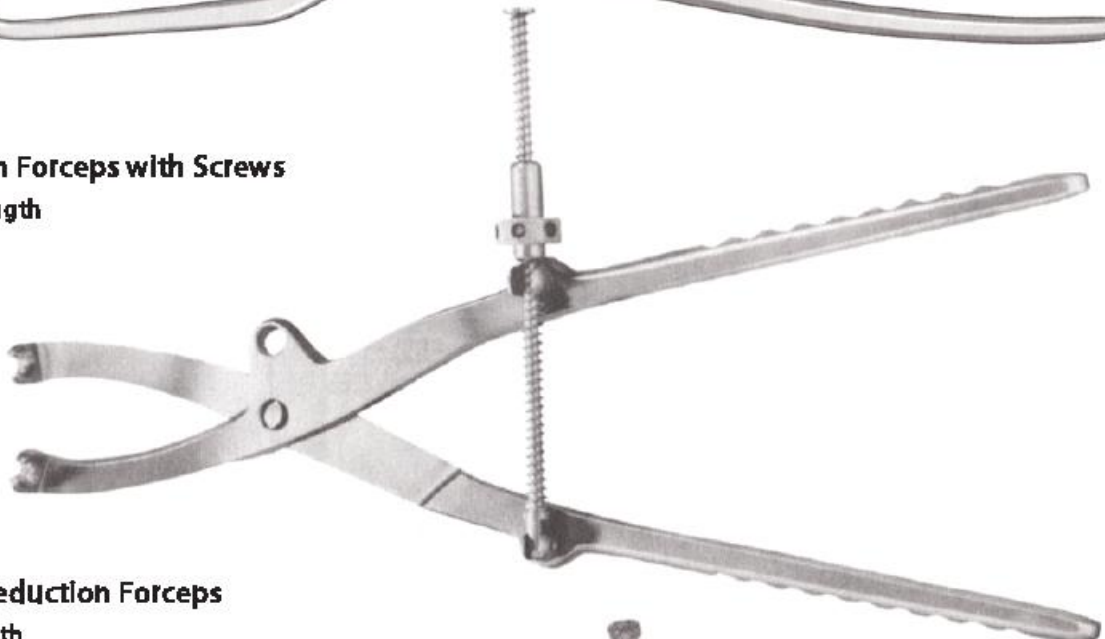

Spanish Bone Reduction Forceps

- 17cm/6 1/2" length

OR 5024-17

- 19cm/7 1/2" length

OR 5024-19

- 24cm/9 1/2" length

OR 5024-24

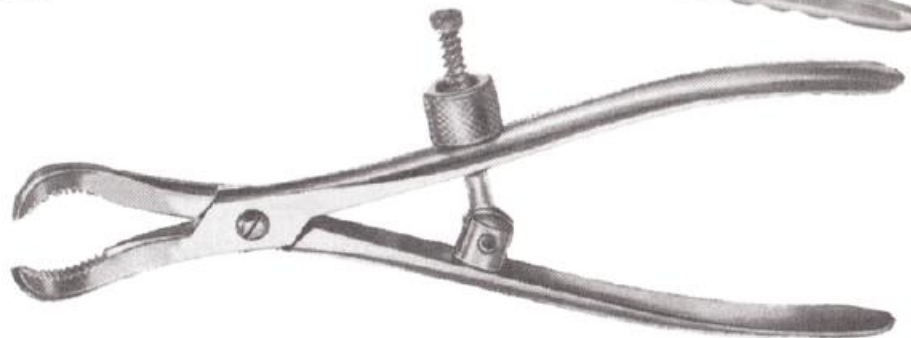

Lowman Bone Holding Forceps

- 14cm/5 1/2" length

OR 6180-14

- 18cm/7" length

OR 6180-18

- 20cm/8" length

OR 6180-20

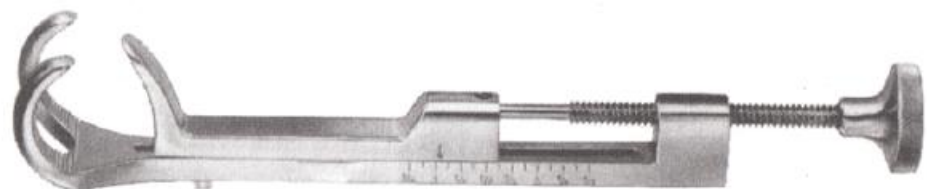

RETRACTORS

Meyering Retractor

- 22cm/9" length



Blade size

OR5050-22	50mm x 16mm
OR5075-22	70mm x 25mm
OR5090-22	90mm x 50mm

Langenbeck Retractor

- 21.5cm/8½" length



Blade size

RT 2522-06	22mm x 6mm	Small
RT 2545-13	45mm x 13mm	Medium
RT 2565-25	65mm x 25mm	Large
RT 2590-20	90mm x 20mm	Extra large

Customised sizes are available

Volkman Retractor

- 21.5cm/8½" length
- Semi sharp teeth



15 x 10mm
2 Prong
RT 209



15 x 15mm
3 Prong
RT 210



15 x 20mm
4 Prong
RT 211



15 x 30mm
6 Prong
RT 212

HIP RETRACTORS

Charnley Initial Incision Retractor Set



Frame only

OR4006-10

OR4006-00 Complete Set - Basic

Consisting of:

- 1x Frame
- 1x Weight & chain
- 1x Square fitting blade - 50mm depth
- 1x Round fitting blade - 40mm depth

OR4006-05 Complete Set - Extended

Consisting of:

- 1x Frame
- 1x Weight & chain
- 3x Square fitting blades:
 - 50mm depth
 - 75mm depth
 - 100mm depth
- 3x Round fitting blades:
 - 40mm depth
 - 75mm depth
 - 100mm depth

Blade with Square Fitting



OR4006-50 Standard depth 50mm

OR4006-75 Extra depth 75mm

OR4006-10 Extra, extra depth 100mm

Blade with Round Fitting

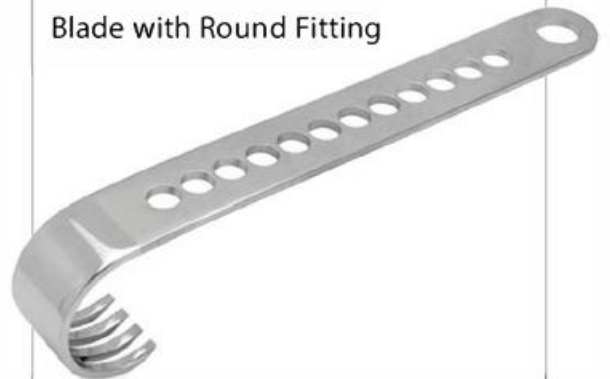

OR4007-40 Standard depth 40mm

OR4007-75 Extra depth 75mm

OR4007-10 Extra, extra depth 100mm

RETRACTORS

Weitlaner S/R Retractor

- 14cm/5½" length
- 3x4 Blunt prongs

OR4002-14



Travers S/R Retractor

- 20cm/8" length
- 4x5 Blunt prongs

OR4004-20



Norfolk and Norwich S/R Retractor

- 20cm/8" length
- 4x5 Blunt prongs

OR4000-20



Gelpi Laminectomy Retractor

- Sharp prongs

	Length	Prong depth
OR4030-16	18.5cm/7¼"	30mm
OR4050-16	19.5cm/7¾"	50mm
OR4070-16	20cm/8"	70mm



RETRACTORS

Charnley Vertical Retractor

- 24.5cm/9½" length
- 3x4 Sharp prongs
- Blade depth 22mm

OR4007-24



Beckman-Weitlaner/ Cones Self Retaining Retractor

- 3x4 Prongs
- Jointed arms

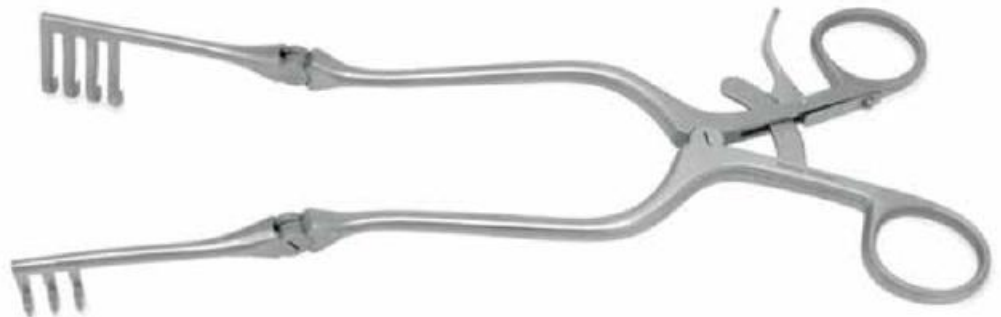

Blunt Prongs	Length	Depth	Sharp Prongs	Length	Depth
OR4064-13	13cm/5"	15mm	SP4063-13	13cm/5"	15mm
OR4066-16	16cm/6 ½"	15mm	SP4065-16	16cm/6 ½"	15mm
OR4068-20	20cm/8"	20mm	SP4067-20	20cm/8"	20mm
OR4070-24	24cm/9 ½"	25mm	SP4069-24	24cm/9 ½"	25mm

Harvey Jackson Self Retaining Retractor

- 30.5cm/12" length
- Blade depth 45mm
- 3x3 Sharp prongs

OR4010-30



Spine Retractor with Hinged Arms and Detachable Blades

- 34cm/13 1/2" length

RT 701-61

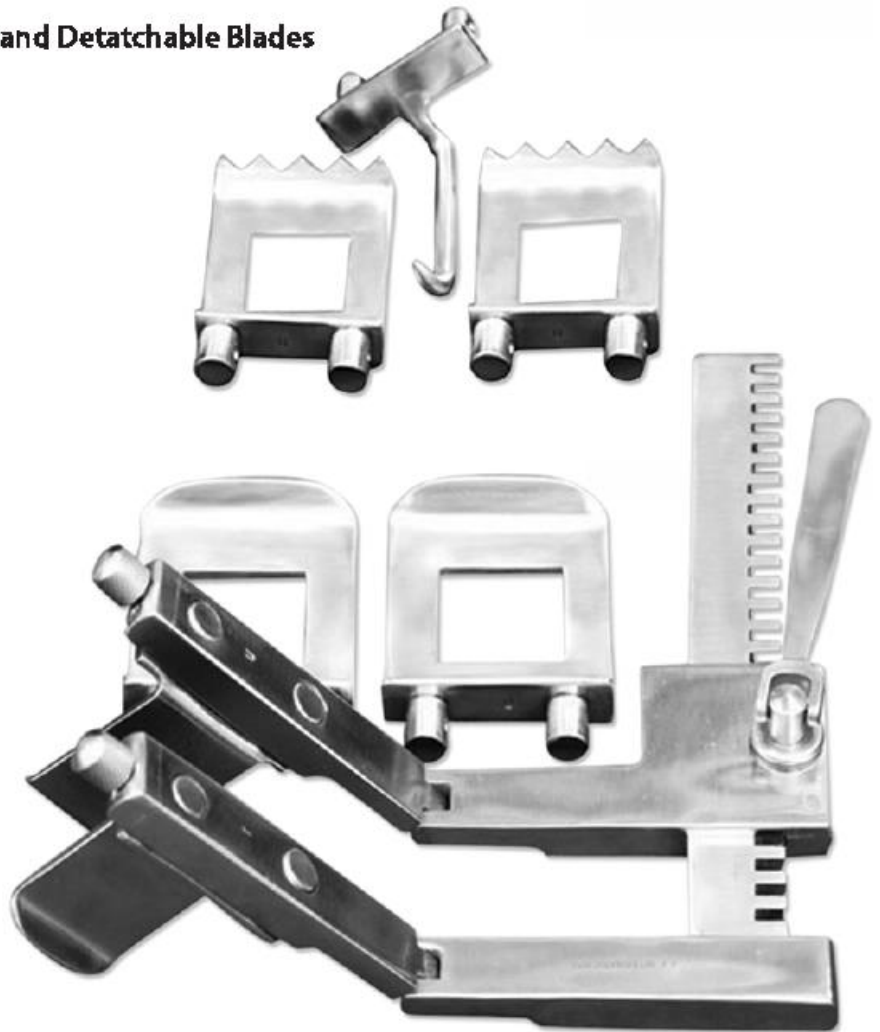

Charnley Pin Retractor

Complete set with:

- T-handle introducer
- Pair of pins with chains

OR1100-00

OR1101-00 T-handle only

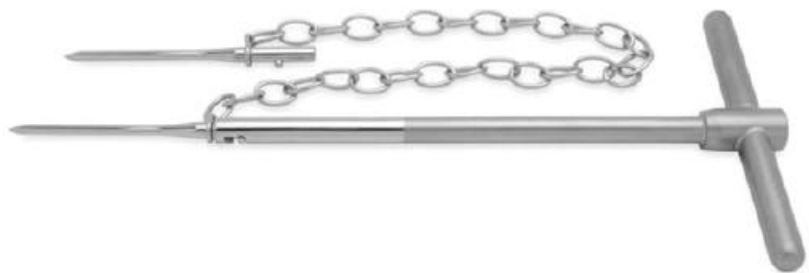

OR1102-00 Pair of pins with chain only

One pin, or sometimes two, is driven into the bone of the superior lip of the acetabulum, to stake back the capsule to give a clear view of the superior lip of the acetabulum. The nerve supply to the tensor fasciae femoris is preserved in this exposure by restricting dissection in the cleft in front of the gluteus medius, but this restricts exposure. By using pins to stake back the abductor muscles, a good exposure of the acetabulum can be obtained, and at the same time the nerve supply to tensor fasciae femoris can be preserved.

The short pins do not obstruct the surgeon's hand in access to the acetabulum. The chain is a safety device to prevent the pins being left in situ.

RETRACTORS

Viper Hinged Scoliosis Retractor

- 30cm/11¾" length
- Sharp

Depth Prongs

OR7248-38H	40mm
OR7248-40H	70mm
OR7248-50H	100mm

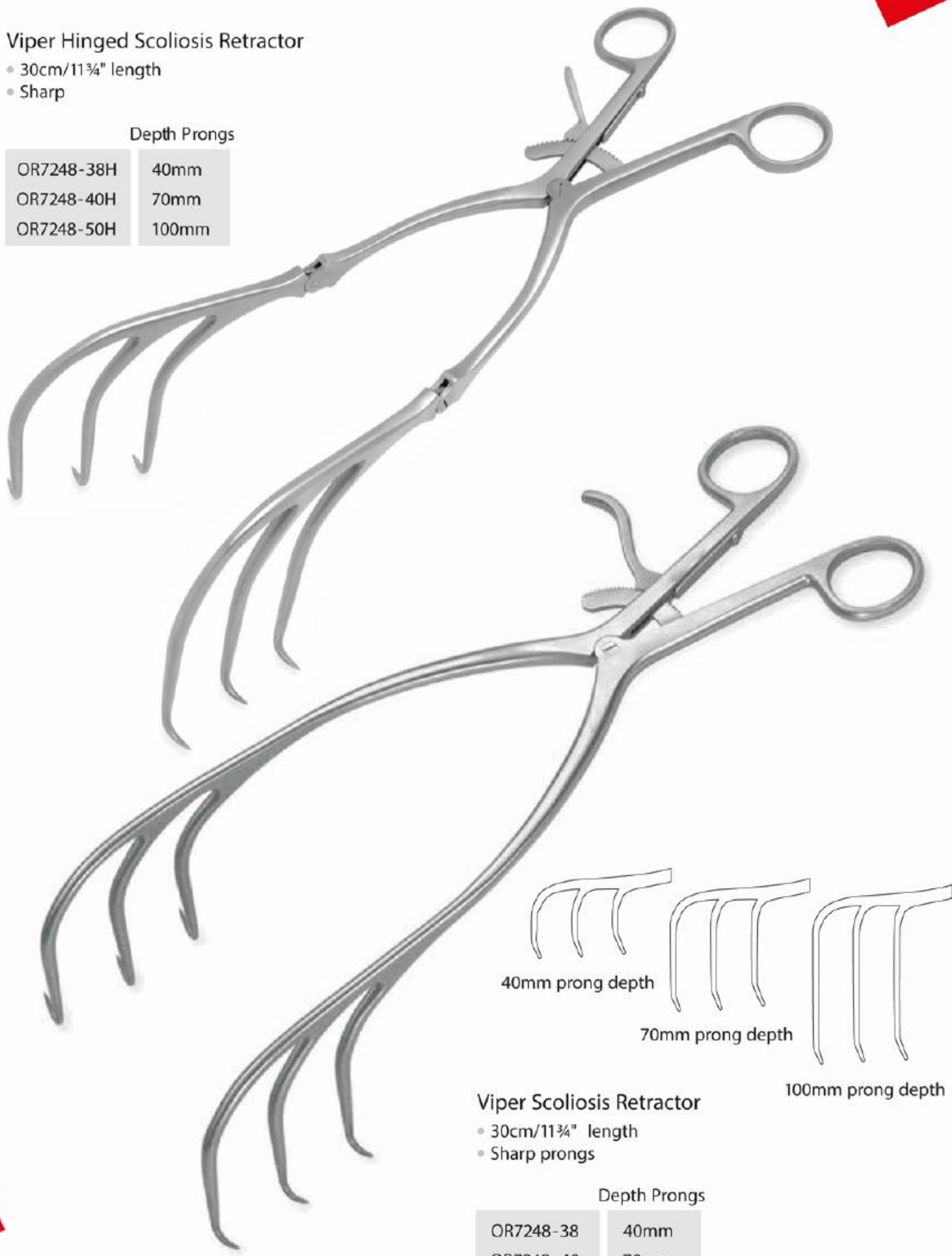

40mm prong depth

70mm prong depth

100mm prong depth

Viper Scoliosis Retractor

- 30cm/11¾" length
- Sharp prongs

Depth Prongs

OR7248-38	40mm
OR7248-40	70mm
OR7248-50	100mm

MALLETS

Toffee Mallet

- 19cm/7½" length
- Head size 22mm Ø
- Weight 165g/6oz

OR5808-21



Ultra Fine Mallet

- 17cm/6¾" length
- Head size 20mm Ø
- Weight 145g/5oz

OR5801-17



Heath Mallet

- 19cm/7" length
- Stainless steel head
- Head size 40mm Ø
- Weight 1020g/36oz

OR5809-19



JJ Mallet

- 23cm/9" length
- Fibre handle
- Head size 40 mm
- Weight 750g

OR 4750-24

- Fibre handle
- Head size 38 mm
- Weight 650g

OR 3800-26

- Fibre handle
- Head size 30 mm
- Weight 200g

OR 3010-20



MALLETS

London Splint Mallet

- 18cm/7" length
- Head size 30mm Ø
- Weight 450g/16.2oz

OR5802-18



Ombredanne Mallet

- 24cm/9½" length
- Head size 40mm Ø
- Weight 550g/20oz

OR5806-24



Mallet with Silicon Handle

- 24cm/ 9" length
- Head size 38 x 32 mm
- Weight 400g

OR 3832-24



Slotted Mallet

- 24cm/ 9" length
- Head size 40 mm
- Weight 650g

OR 4000-65



OSTEOTOMES

Mini-Lambotte Osteotome



12.5cm/5" length	Width	17.78cm/7" length	Width
OR 5205-02	2mm	OR 5207-02	2mm
OR 5205-03	3mm	OR 5207-03	3mm
OR 5205-04	4mm	OR 5207-04	4mm
OR 5205-06	6mm	OR 5207-06	6mm
OR 5205-08	8mm	OR 5207-08	8mm

Lambotte Osteotome

▫ 25cm/9¾" length



Straight	Width	Curved	Width
OR7970-04	4mm	OR7971-04	4mm
OR7970-06	6mm	OR7971-06	6mm
OR7970-08	8mm	OR7971-08	8mm
OR7970-10	10mm	OR7971-10	10mm
OR7970-13	13mm	OR7971-13	13mm
OR7970-16	16mm	OR7971-16	16mm
OR7970-18	18mm	OR7971-18	18mm
OR7970-20	20mm	OR7971-20	20mm
OR7970-25	25mm	OR7971-25	25mm
OR7970-30	30mm	OR7971-30	30mm

Ultra Fine Osteotome

▫ 16cm/6¼" length



	Width
OR5230-02	2mm
OR5230-04	4mm
OR5230-06	6mm
OR5230-08	8mm
OR5230-10	10mm
OR5230-12	12mm



Set of 6 sizes: 2mm to 12mm complete with mallet in sterilising case

OR5230-48

OSTEOTOMES

Mini- Stille Osteotome

- 16cm/6¼" length

Straight	Width
OR7704-16	4mm
OR7706-16	6mm
OR7708-16	8mm



Stille (Swedish) Osteotome

- 20cm/8" length

Straight	Width
OR 7708-06	6mm
OR 7708-08	8mm
OR 7708-10	10mm
OR 7708-12	12mm
OR 7708-15	15mm
OR 7708-20	20mm
OR 7708-25	25mm
OR 7708-30	30mm



Curved	Width
OR 7608-06	6mm
OR 7608-08	8mm
OR 7608-10	10mm
OR 7608-12	12mm
OR 7608-15	15mm
OR 7608-20	20mm
OR 7608-25	25mm
OR 7608-30	30mm

Hibbs Osteotome with thin blade

- 20cm/8" length
- Extra thin blade

Straight	Width
OR 7808-04	4mm
OR 7808-06	6mm
OR 7808-08	8mm
OR 7808-10	10mm
OR 7808-12	12mm
OR 7808-15	15mm
OR 7808-20	20mm
OR 7808-25	25mm
OR 7808-30	30mm



Curved	Width
OR 7908-04	4mm
OR 7908-06	6mm
OR 7908-08	8mm
OR 7908-10	10mm
OR 7908-12	12mm
OR 7908-15	15mm
OR 7908-20	20mm
OR 7908-25	25mm
OR 7908-30	30mm

Smith Petersen Osteotome

- 20cm/8" length

	Width
OR7610-20	10mm
OR7615-20	15mm
OR7620-20	20mm
OR7625-20	25mm
OR7630-20	30mm



OSTEOTOMES

JJ Osteotomes

- 25cm/10" length



Straight		Curved	
	Width		Width
OR 6009-05	5 mm	OR 6109-05	5 mm
OR 6009-10	10 mm	OR 6109-10	10 mm
OR 6009-15	15 mm	OR 6109-15	15 mm
OR 6009-20	20 mm	OR 6109-20	20 mm
OR 6009-25	25 mm	OR 6109-25	25 mm

Lexer Osteotome

- 22cm/8½" length
- Fibre handle



	Width
OR7207-22	7mm
OR7210-22	10mm
OR7215-22	15mm
OR7220-22	20mm
OR7225-22	25mm

Dahmen Osteotome

- 30cm/12" length
- Fibre handle



	Width	Straight		Angled		
			Width		Width	
	5mm		OR7105-30	5mm	OR7305-30	5mm
	10mm		OR7110-30	10mm	OR7310-30	10mm
	15mm		OR7115-30	15mm	OR7315-30	15mm
	20mm		OR7120-30	20mm	OR7320-30	20mm
	25mm		OR7125-30	25mm	OR7325-30	25mm
	30mm		OR7130-30	30mm	OR7330-30	30mm

OSTEOTOMES & GOUGES

Box Chisel

- For preparation of the proximal femur
- 23cm/9" length
- 22mm width x 4 mm

OR 17803

- 25cm/10" length
- 28mm width x 6 mm

OR 17802



Pelvic Osteotome

- 30cm/12" length
- Tufnol handle
- Angled shaft



15mm width

20mm width

OR7015-30

SP7020-30

Chisel with Interchangeable Blades

- 20cm/8" length
- Tufnol handle
- Very thin blades



OR0790-20

Complete set with 4 blades* & key

Blade Width

OR0792-05	5mm*
OR0793-08	8mm
OR0793-10	10mm*
OR0793-12	12mm
OR0794-15	15mm*
OR0795-25	25mm*

Capener Lamina Gouge

- 23cm/9" length
- Cranked shaft



Width

OR6506-23	6mm
OR6508-23	8mm
OR6511-23	11mm
OR6516-23	16mm

BONE CURETTES

Volkman Curette

- 22cm/8¾" length
- Double ended

	Size
OR8401-22	Small
OR8402-22	Medium
OR8403-22	Large

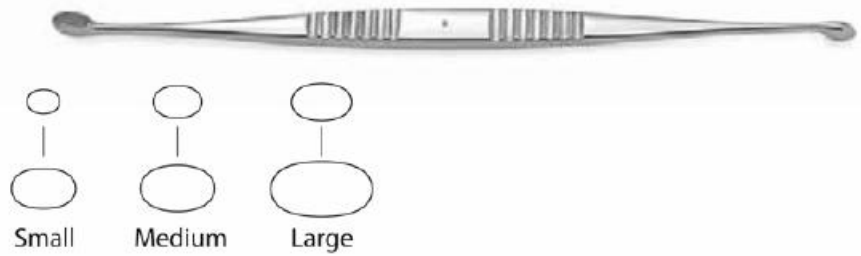

Muller Curette with Tufnol Handle

- 27cm/9¾" length
- Tufnol handle



Charnley Bone Curette

- 37cm/15" length
- T-handle



Charnley Ring Curette

- 37cm/15" length
- Double sided
- Serrated cutting edge
- T-handle



HIP REVISION INSTRUMENTS

Cup Extraction Chisel

- 32cm/12½" length
- Curved 7mm tip
- Metal strike plate
- Tufnol handle



OR6507-32

Bayonet Gouge

- 32cm/12½" length
- Metal strike plate
- Tufnol handle
- 8mm width



OR6508-32

Swan Necked Gouge

- 28.5cm/11" length
- 25mm width



OR6525-28

Cement Gouge

- 34.5cm/13½" length



9mm width
SP6509-34

11mm width
SP6511-34

Cement Chisel Angled 15°

- 35.5cm/14 length
- 9mm tip



OR6109-35



HIP REVISION INSTRUMENTS

Cement Osteotome

- 30cm/12" length
- Tufnol handle with strike plate

	Width
OR6105-30	5mm
OR6107-30	7mm
OR6110-30	10mm



Cement Splitting Osteotome

- 30cm/12" length
- Tufnol handle with strike plate
- Guarded blade

	Width
OR6205-30	5mm
OR6210-30	10mm



Straight Cement Gouge

- 30cm/12" length
- Tufnol handle with strike plate

	Width
OR6305-30	5mm
OR6307-30	7mm
OR6310-30	10mm



Bayonet Cement Rasp

- 52cm/20½" length
- Tufnol handle

*illustrated



OR6100-52



V-shape

OR6101-52



Strong round shape*

OR6102-52



Flat round curve

Bayonet Cement Chisel

- 40cm/15¾" length
- Tufnol handle with strike plate



Bayonet Cement Splitting Osteotome

- 40cm/15¾" length
- Tufnol handle with strike plate
- Guarded blade



Bayonet Cement Gouge

- 40cm/15¾" length
- Tufnol handle with strike plate



Bayonet Cement Gouge

- 40cm/15¾" length
- Tufnol handle with strike plate



HIP REVISION INSTRUMENTS

Malleable Cement Probe

- 38cm/15" length
- For probing the Femur



OR6900-38



Cement Plug Extractor

- 48cm/19" length
- T-handle
- For extraction of cement plug



Thread Dia.

OR6807-48

7mm

OR6809-48

9mm

OR6811-48

11mm



Used with a slotted mallet

Retrograde Cement Chisel

- 50cm/19¾" length
- Tufnol T-handle
- Striking plate



Width

OR6805-50

5mm

OR6807-50

7mm

OR6810-50

10mm



Slotted Mallet

OR6850-00



Cement Extraction Hook

- 34.5cm/14" length

OR6905-34

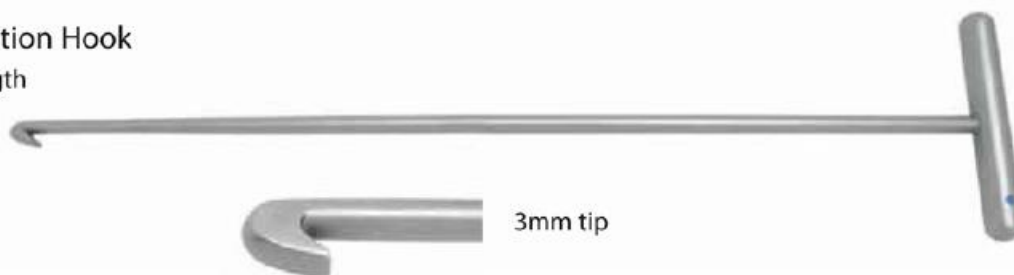

3mm tip

HIP REVISION INSTRUMENTS

Cement Twist Drill Long

- 40cm/15¾" length



Diameter

OR1400-06	6mm
OR1400-08	8mm
OR1400-10	10mm

Fine Cement Duckbill Grasping Forceps

- 35cm/14" shaft length
- Fine jaws



OR6901-35



Heavy Cement Grasping Forceps

- 26cm/10" shaft length
- Serrated jaws 6mm width



OR6902-26



HIP REVISION INSTRUMENTS

Femoral Head Extractor

- 23cm/9" length
- Tufnol handle

SP6916-23



Moore Femoral Head Extractor

- 20.5cm/8" length
- Metal handle

SP6914-20



Joint Capsule Clamp

- 21cm/8¼" length
- 25mm jaw length

SP6995-21



Joint Capsule Scissors

- 25cm/9¾" length
- Angled blades

SP6910-25



HIP JOINT INSTRUMENTS

Femoral Head Impactor

- 20cm/8" length
- Nylon head

SP6918-20



McGoey Bone Punch

- Double ended



* illustrated

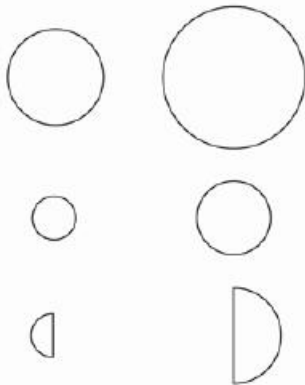

No 1. 13mm x 19mm Ø **OR6913-19** Large size

No 2. 6mm x 10mm Ø **OR6906-10** *Small size

No 3. 6mm x 13mm Ø **OR6906-13**
With flats

Hardinge Cement Restrictor

- 33.5cm/13³/₄" length
- Graduated shaft



OR6920-33

Femoral Pusher

- Square ended

OR6925-20

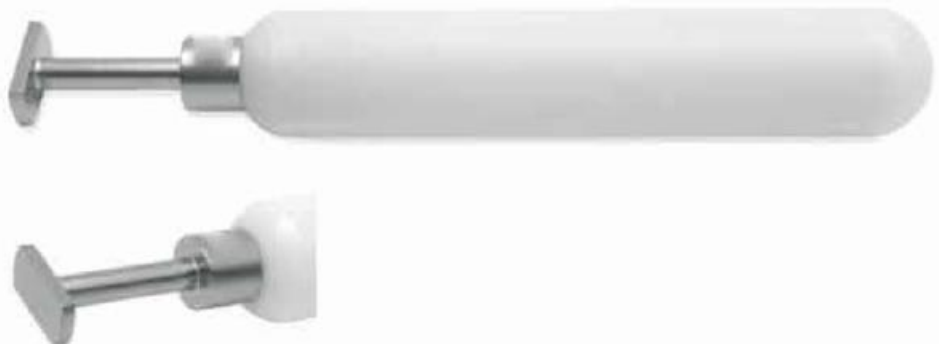

PLIERS & WIRE CUTTERS

Multi Purpose Pliers

- 20cm/8" length

OR 00802

- 17cm/7" length

OR 00801



Dolphin Nose Pliers

- 18cm/7" length

OR 00143



Long Nose Pliers

- 15cm/6" length

OR 00142



Slim & Square Ended Wire Pliers

- 19cm/7½" length



Slim Nose

OR7645-19

Serrated jaw



Square Ended*

SP7644-19



Pliers for Damaged Screws

- 20cm/8" length

OR 00329

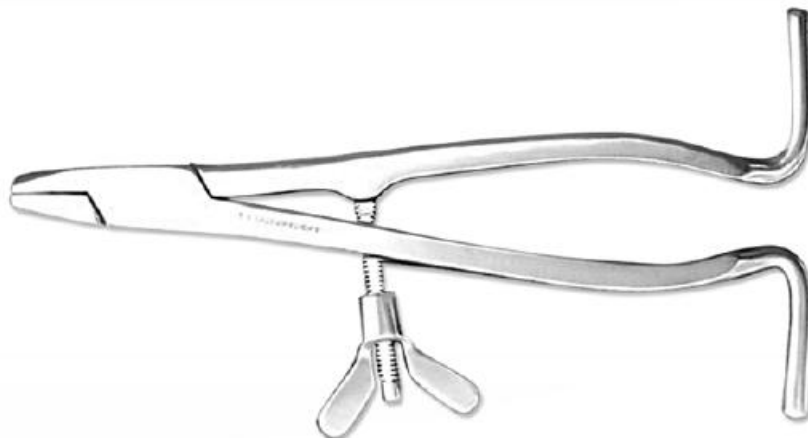

Muller Claus Wire Pullers

- 18cm/7" length
- Double action
- Tungsten jaws



2mm Jaws

8-818E18



4mm Jaws

8-820E18



6mm Jaws

8-821E18



PLIERS & WIRE CUTTERS

Muller Claus Wire Cutters

- 16cm/6" length
- Tungsten carbide edges
- Cuts wire up to 1.6mm Ø

8-810E16



Muller Claus Wire Cutters

- Tungsten carbide edges

8-810E18

- 18cm/7" length*
- Cuts wire up to 2mm Ø

8-800E22

- 22cm/8¾" length
- Cuts wire up to 3mm Ø



*illustrated

End Wire Cutters

- 18cm/7" length
- Tungsten carbide edges
- Cuts wire up to 1.7mm Ø

8-816E18



Bolt Cutters with dismantable arms

- Max. cap 6.3mm pins

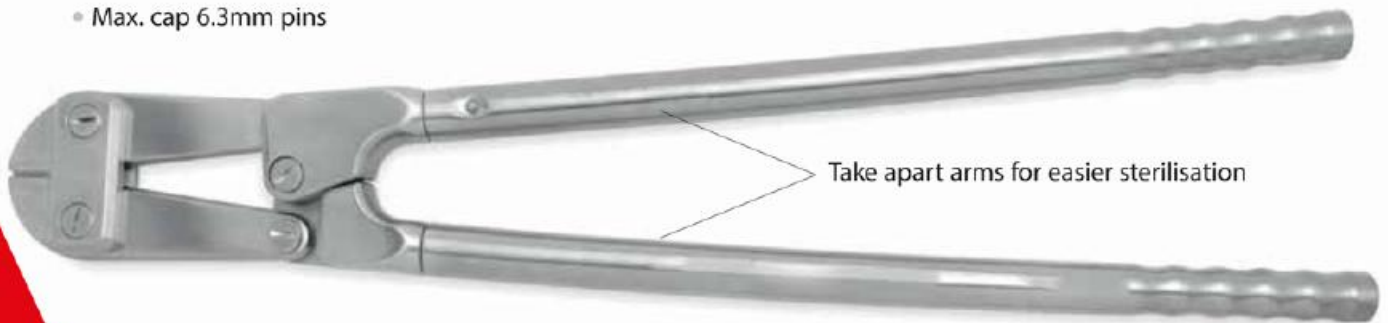

Take apart arms for easier sterilisation

200-500-585

- Must be used in conjunction with a Rod Holder. Ordering Code: 200-675-200

WIRE CUTTERS

Combined Wire Cutters & Pliers

- 18cm/7" length
- Suitable for wires up to 1.6mm Ø
- Parallel closing jaws

200-512-185



Wire Cutters with T/C Jaws

- 24cm/9½" length
- Double action
- Cuts plates & wires up to 2.7mm Ø

OR7644-24



Arjuna K Wire Cutter

- 20cm/8" length
- Cutting inserts are T/C and can be replaced
- Cuts wires up to 3mm Ø

OR 00377



LOCKING PLIERS

Needle Nosed Locking Pliers



Code	Length	
200-514-220	22cm/8¾"	Small
200-515-250	25cm/9¾"	Medium
200-516-300	30cm/11¾"	Large

- A very useful instrument for orthopaedic surgery allowing the surgeon to securely clamp on to wires and implants.



Slap Hammer attachment combined

Code	Length	Weight
210-400-350	35cm/13¾"	400g
210-700-350	35cm/13¾"	700g

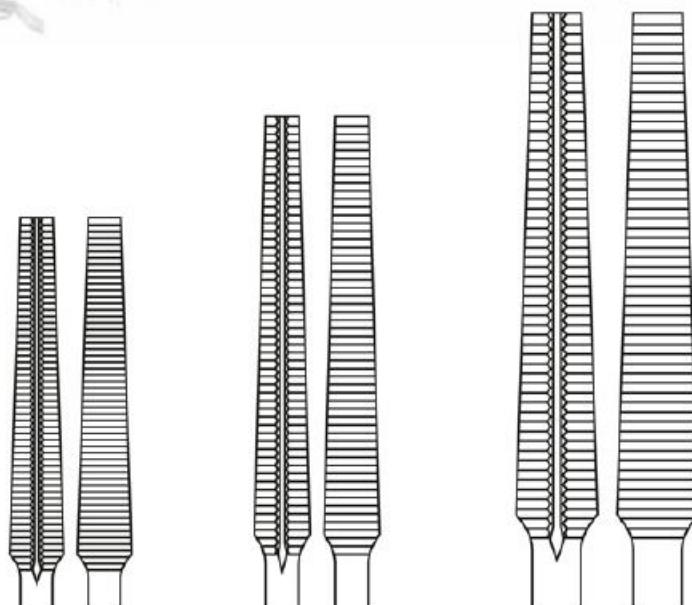

22cm/8¾" Small

25cm/9¾" Medium

30cm/11¾" Large

JJ Orthopaedic Locking Pliers

- Hardened jaws



Code	Length	
OR 00339	18 cm/7"	Small
OR 00338	28 cm/11"	Large

Slap hammer attachment



Code	Length	Weight
OR 00339-00	25 cm/10"	400 g
OR 00338-00	35 cm/13"	700 g

PIN INTRODUCERS

Kirschner Wire Introducing T-Handle

- 12cm/4¾" length
- 1.5mm Ø wires

OR5015-12



Steinmann Pin Introducer T-Handle

- 14cm/5½" length
- 0.5mm - 8mm Ø pins
- With Jacobs chuck & key

OR5502-14



Steinmann Pin Introducer T-Handle

- 14cm/5½" length
- 0.7mm - 6mm Ø pins
- Universal chuck

OR5507-14



Raindrop K-wire Holder

- A Chuckless K-wire holder for 0.5 to 2.5mm K-wires

OR 00410

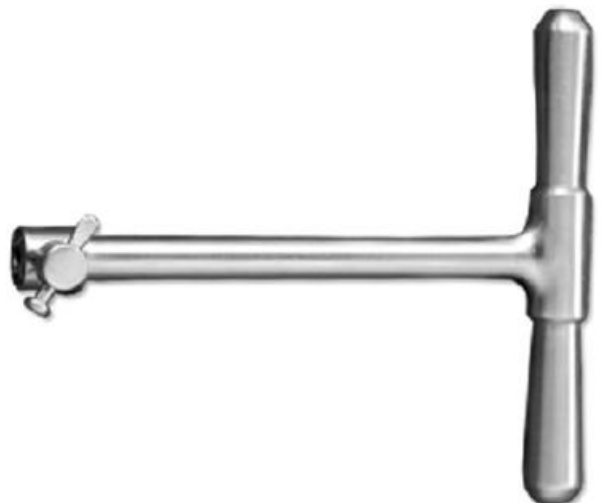

Bone Mill

- Table mounted with crank handle

OR 6001-00

For grinding bone chips used for bone graft procedures.



Wire Passing Guide

- 21cm/8¼" length

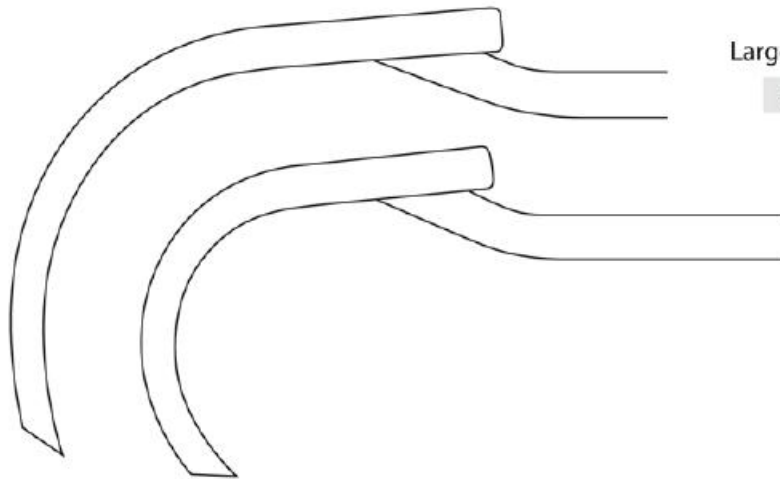

Large curve 70mm Ø

OR6105-21

Small curve 45mm Ø

OR6104-21

Bone Awl

- Straight with eye

	Diameter	Length
OR5602-12	2.0mm	125mm
OR5602-13	2.4mm	130mm
OR5602-14	2.8mm	145mm
OR5602-15	3.2mm	160mm
OR5602-16	3.6mm	165mm
OR5602-17	4.0mm	175mm



SCREWDRIVERS

Slotted Head

- 17cm/6¾" length
- For head screws 2.7mm - 4.0mm

OR7014-17

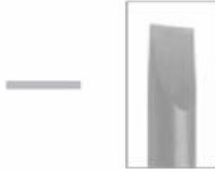

Long Slotted Head

- 25cm/10" length
- For head screws 2.7mm - 4.0mm

OR7014-25



Phillips Head

- 25cm/10" length
- For small Phillips head screws 6mm

OR7015-25



Cross Slotted Head

- 25cm/10" length
- For cross slot screws 6mm

OR7016-25



SCREWDRIVERS

Hexagonal Head

- 25cm/10" length
- For hexagonal head screws 2.7mm - 4.0mm

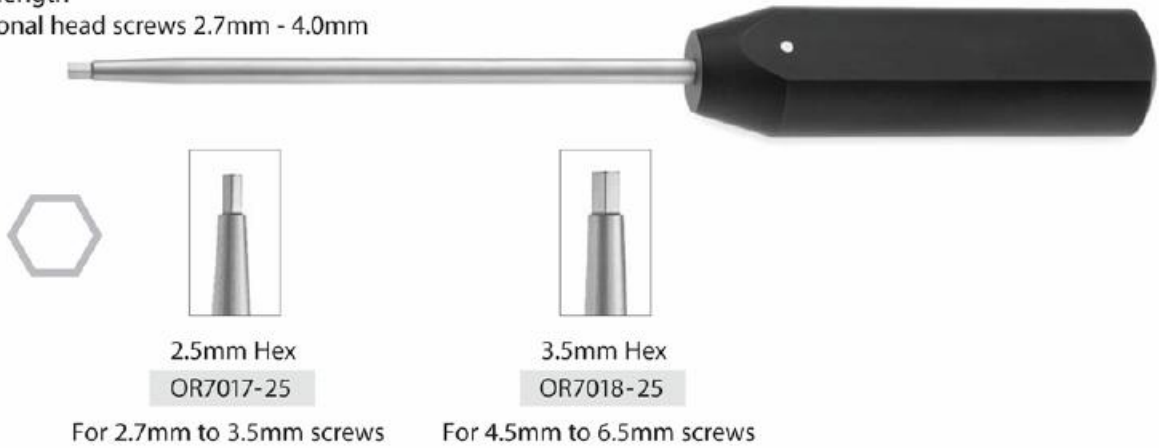

Screwdriver Handle

- To fit shafts with quick lock attachment

OR7020-02



Screwdriver Handle Small

- To fit shafts with quick lock attachment

OR7020-01



Shaft with Quick Lock Fitting

- Hexagonal tip



Shaft	Diameter
OR7021-00	2.5mm
OR7022-00	3.5mm

DISSECTORS

Howarth Elevator

• 21.5cm/8½" length



PS 9207-21

MacDonald Elevator/Dissector



Size

PS 7105-19 19cm/7 ½"

PS 9206-23 23cm/9"

Watson Cheyne Dissector



Length

PS 7203-18 18cm/7"

PS 9203-23 23cm/9"

PS 9203-25 25.5cm/10"

Freers Elevator/Dissector

• 18.5cm/7¼" length



PS 7602-18

Swedish Dissector

• 18cm/7" length



PS 9201-18

Stainless Steel Measuring Ruler

Code	Length
OR5005-15	15cm/6"
OR5005-30	30cm/12"



Measuring Caliper

- 25cm/10" length
- Measuring range 0-50mm

OR7334-20



Vernier Caliper

- 22.5cm/9" length
- Measuring range 15cm

OR7338-00



Depth Gauge

- Measuring depth up to 50mm

OR7350-00



Depth Gauge

- Measuring depth up to 70mm

OR7370-00



SHOULDER SURGERY INSTRUMENTS



International Instruments
Designers & Manufacturers of Surgical Instruments

Penetrating Bone Gouge

- 22cm/8 3/4" length
- 3mm wide tip

SM0804-22



Percussion Bone Awl

- 22cm/8 3/4" length
- Curved, with metal handle

SM0805-22

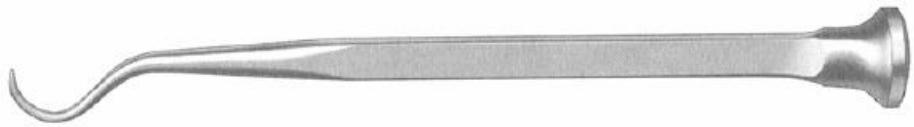

Penetrating Bone Awl

- 18cm/7" length
- Tufnol handle

SM0806-18



Crochet Hook Suture Passer

- 18cm/7" length
- Tufnol handle

SM0807-18



Suture Passer

- 18/7"cm length
- Tufnol handle
- With hole in tip

SM0808-18



The Bone Awls and Suture Passers are used to place sutures along the edge of the Glenoid Rim.

Glenoid Perforating Forceps

- 17cm/6 3/4" length

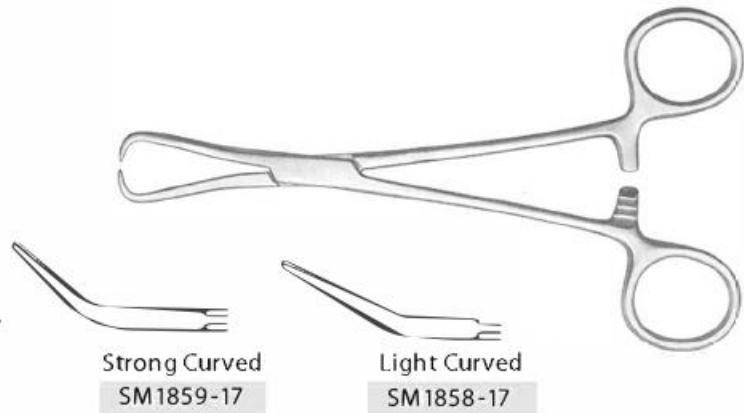

For perforating holes in the Glenoid Rim.

Strong Curved
SM1859-17

Light Curved
SM1858-17

Kolbel Glenoid Elevator

- 30cm/12" length
- 15mm width
- Curved
- Double prong

SM0596-15



Kolbel Glenoid Elevator

- 30cm/12" length
- 20mm width
- Curved
- Double prong

SM0598-20



Posterior Glenoid Elevators

- Curved tip to sit on posterior rim of Glenoid
- For Posterior Retraction of the Humeral Head



Width tip

SM0575-08

8mm

SM0575-12

12 mm

SM0575-20

20mm

HUMERAL HEAD RETRACTORS

Fukuda Humerus Head Retractor

- 22.5cm/9" length
- Fenestrated

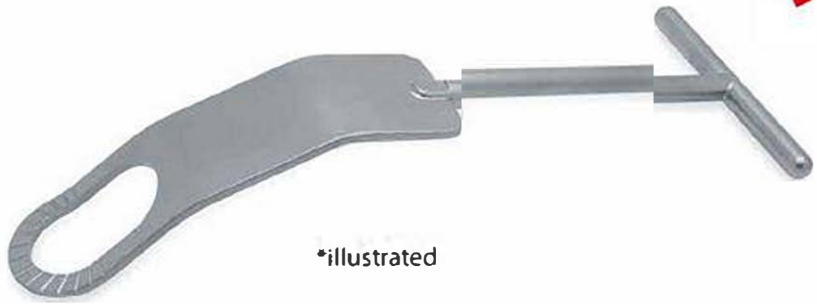

*illustrated

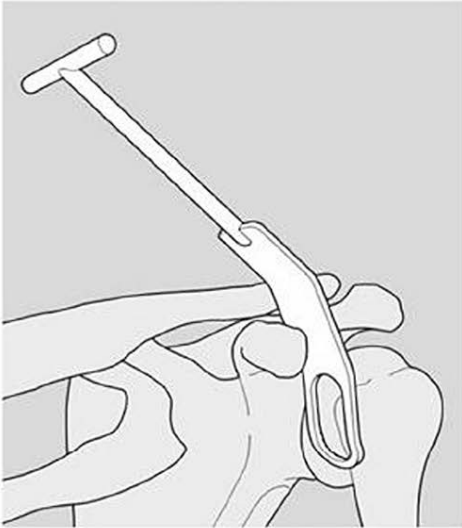

	width
SM0594-32	32mm
SM0594-35	35mm*
SM0594-37	37mm

Humerus Head Retractor

- 18cm/7" length
- Strongly curved
- Double blunt prongs

SM0592-18



ELEVATORS

Bhattman Humerus Head Retractor

- 25cm/9 3/4" length
- 30mm width
- Double prong

SM0590-30



Humeral Head Retractor

- 22cm/8 3/4" length

SM 0592-21



Darrach Acromial Elevators



*illustrated

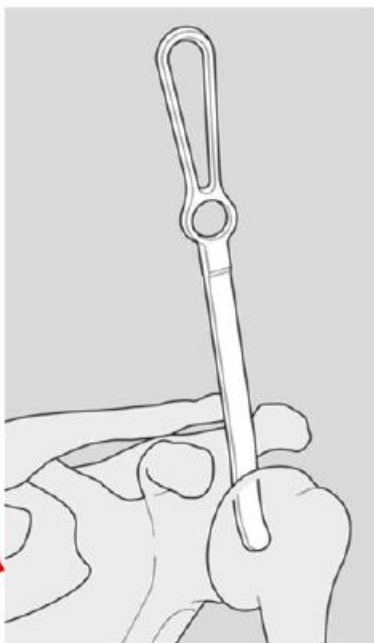

Small 9mm width, 26cm/10 1/4" length

SM0599-09



Medium 12mm width, 26cm/10 1/4" length

SM0599-12



Large 16mm width, 26cm/10 1/4" length*

SM0599-16



Extra Large 25mm width, 36cm/14 1/4" length

SM0599-25

Set of 4 Elevators

SM0599-00

SUB-ACROMION SPREADERS

Subacromion Spreader

- 19cm/7 1/2" length
- Small size

OR6551-19 left side ring*

OR6552-19 right side ring



illustrated*

Subacromion Spreader

- 25cm/9 3/4" length
- Large size

6553-25 left side ring*

SM6554-25 right side ring



illustrated*

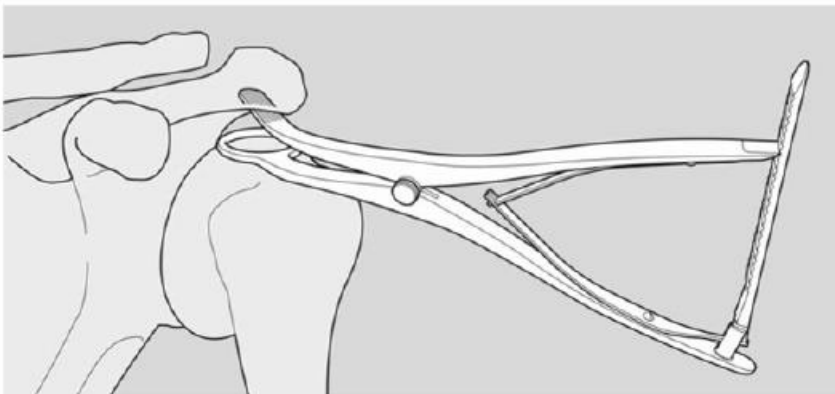

These spreaders are used when access is required to the subacromion area. The spreaders distract the humeral head from the acromion.

Subscapularis Spreader

- 18cm/7" length

SM 6442-18



Kolbel soft Tissue Retractors

- 18cm/7" length

SM 6444-18



Hendren Self Retaining

- For tissue and back subcutaneous fat
- 16cm/6 1/2" length
- 22mm x 14mm blades

SM 1063-16

- 14cm/5 1/2" length
- 18mm x 13mm blades

SM 1063-14

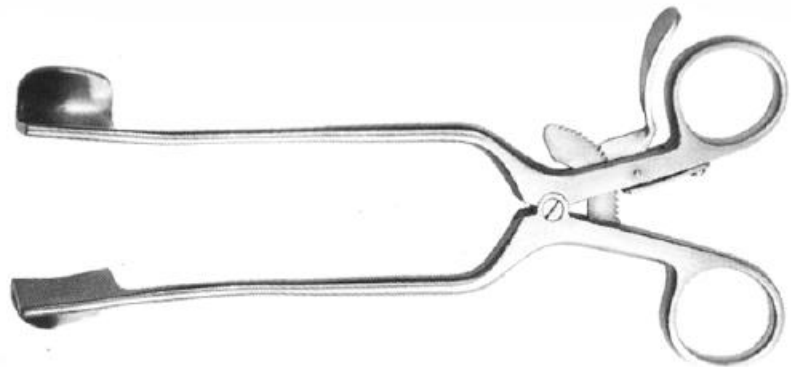

Kolbel Self Retaining Glenoid Retractor with Center Blade

- 20cm/8" length

SM 1063-20

- Center blade
- Depth 6.4cm/2.5"

SM 1063-21

- Blades - pair
- 36mm x 36 mm

SM 1063-36

- Blades - pair
- 36mm x 53 mm

SM 1063-53



SOFT TISSUE RETRACTOR

Kolbel Shoulder Retractor

- With 3 pairs of detachable blades
- 23cm/9" length

SM1062-23

Complete set with 3 pairs of blades and retractor frame

SM1062-00

Retractor frame only



SM1063-36
Small blade



SM1064-53
Medium blade



SH1065-68
Large blade

Browne Deltoid Retractor

- 27cm/10 1/2 length
- 60mm x 65mm blade
- Cupped blade

SM0500-27

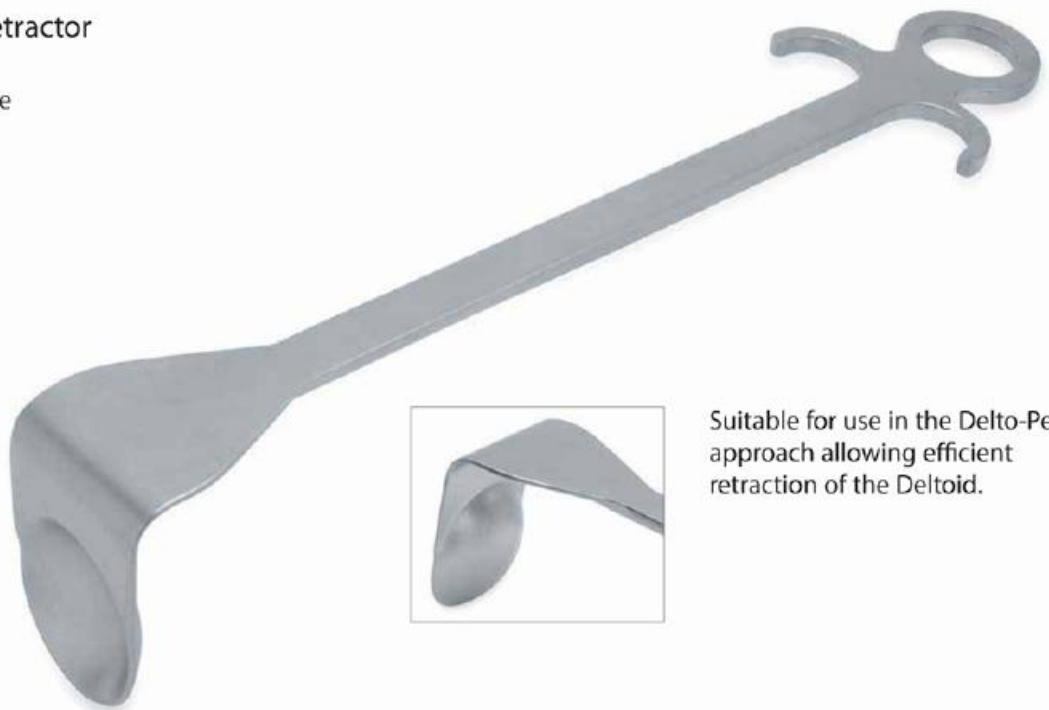

Suitable for use in the Delto-Pectoral approach allowing efficient retraction of the Deltoid.

SHOULDER RETRACTOR

Titanium Bladed Shoulder Retractor

Complete set with:

- 1x Frame
- 2x Blade holders
- 2 Sets of Titanium blades
- Sterilizing container

SM1007-00



Frame with Articulating Joints

- Quick lock + unlock for blades
- Maximum spread 10cm

SM1088-00



Blade Holder

SM1009-00

Titanium Retractor Blades

- 30 angled
- Small blade size 22mm x 55mm
- Large blade size 22mm x 65mm



MISCELLANEOUS

Rotator Cuff Awl

- 25cm/10" length

SM 0805-24



Arthroscopic Shoulder Rasp

- 25cm/10" length

SM 231-01



Cement Removal Gouges

- 22.9cm/9" length

OR 6305-23 width
5mm



OR 6307-23 7mm



OR 6309-23 9mm



OR 63011-23 11mm



Offset Retractors

- 21.6cm/8.5" length
- Leg depth 7.5 cm/3"

RT 4818-44





International Instruments

Designers & Manufacturers of Surgical Instruments

Corporate Office & Factory

337/N, Amala Antonian Plaza
Kinfra Park P.O., Thrissur (Dt.)
Kerala State, India - 680 309
Tel : +91 480 273 5959 / 5858

USA Office

12916 Edsel Dr.
Raleigh NC 27613
USA
Tel : +1 919 467 5278

Middle East Office

211 Bait Al Ali Building
Al-Khuwair, Muscat
Oman
Tel : +968 99053791

sales@myjjonline.com, myjjonline@yahoo.com

www.myjjonline.com

