

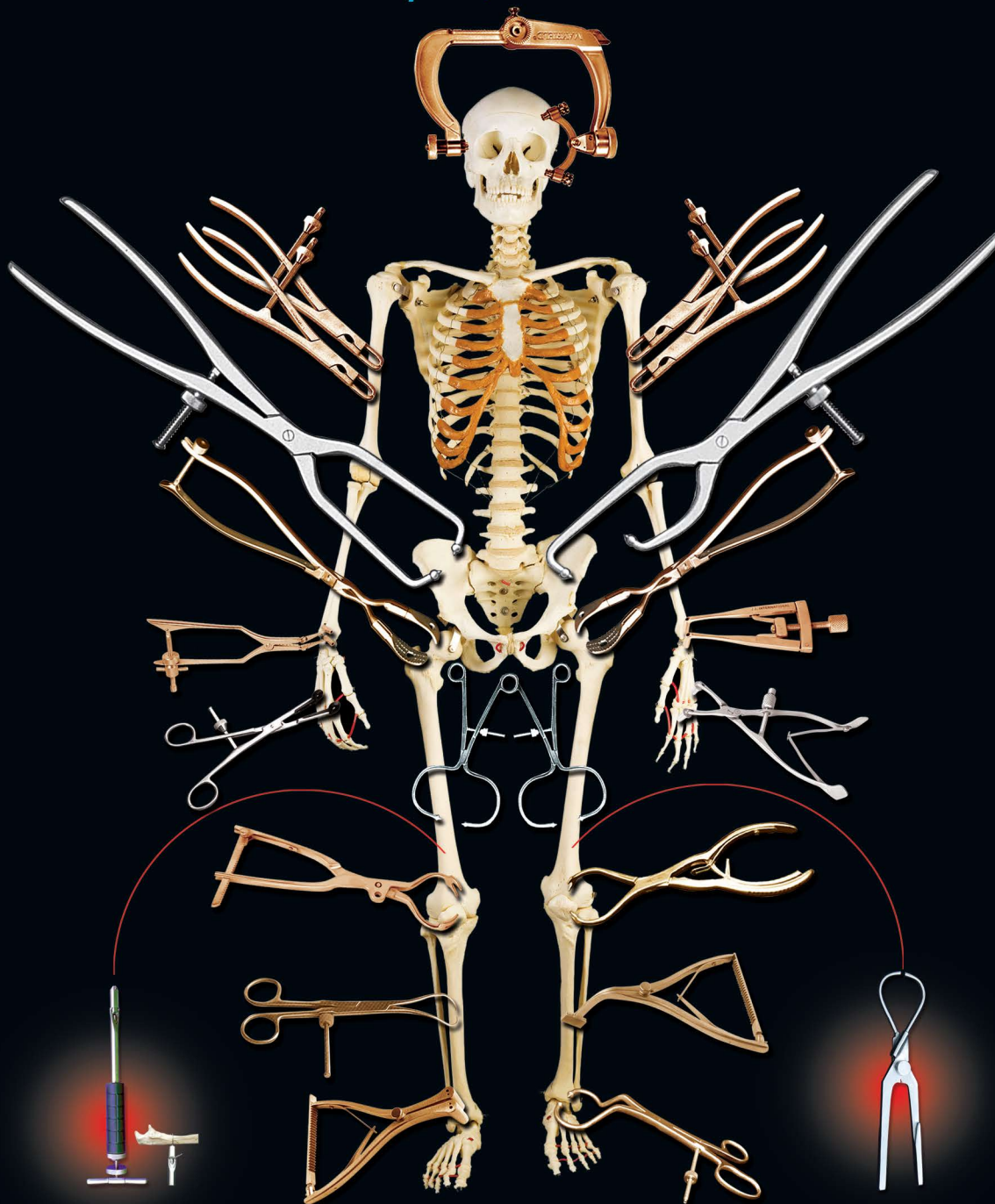

International Instruments

Designers & Manufacturers of Surgical Instruments

USFDA, CE, ISO & CDSCO REGD.



www.myjjonline.com

sales@myjjonline.com, myjjonline@yahoo.com

INDIA

Corporate Off. & Factory:
Kinfra Park P.O.
Thrissur Dist., Kerala
India - 680 309
+91 480 2735959

UAE

Sales Office:
AL Smookh Building
Umm Al Quwain,
UAE
+971 50 7571358

OMAN

Service & Sales Office:
Suite 122, Bldg 579
Maabela Industrial Area
Muscat, Oman
+968 9905 3791

USA

Sales Office:
1000 Centre Greenway
Suite 200, Cary
North Carolina 27513
+1 919 467 5278

**Damaged Screw
 Extractor Set**

New!



Screw retriever



OR00329

Padmasree Dr.S.M.Hardikar
 Facilitates the removal of
 damaged screws. Suitable
 for 3.5 & 4.5 screws

**Locking Driver
 Left**



4.5 3.5

Carbide Bits



5 4 3.5 2.5

Hollow - mill



2.7 - OR00332
 3.5 - OR00334
 4.5 - OR00335
 6.5 - OR00336

**Dr. Mani
 JJ Bone Clamp**



OR00347 Forearm
 OR00349 Humerous
 OR01347 Paediatric

Designed by Prof. N.J. Mani
 A great time saver in Fore
 arm / Humerus reduction.
 Plate inserting facility without
 disturbing reduction

**Arjuna K Wire
 Cutter**



OR00377

K wire Cutter with tungsten
 Carbide Tip for K-wire
 up to 2.5 mm

**Sachin K Wire
 Cutter**



OR00378

K wire Cutter with tungsten
 Carbide Tip for K-wire
 up to 1.5 mm

New!

**Broken Interlocking
 Nail extractor**



OR00325

Unique thread design useful
 for Brocken nails. Designed
 to be used in a counter
 Clock wise direction

JJ Interlocking Rasp



OR00343
 Humerous

OR00342

Tiilbea & Femour

Dr.N.J.Karne,Pune
 The Cannulated Rasp to widen
 the interlocking entry point
 from 8mm to 13mm

**JJ Implant Extractor
 with Slap Hammer**



OR00338 Large
 OR00339 Small

The tungsten tipped extractor
 for square nails, interlocking
 nails,K-nails,K-wires,Rush nails
 knowled pins,AM pins, Screws etc.

**Wire Twister with
 Self Cutting**



OR00345

Wire Tensioner with automatic
 cutting. An innovating instrument
 for cerclage wiring.

**Universal Interlocking
 Nail Extractor**



9 Cannulated Adaptors

OR00330-03

Extractor for any interlocking
 nails of any make

Small bone Compressor/Distractors

New!



OR00412R-00
 Radiolucent



With Fixed & Rotated Arm Alm- JJ



Fixed Arm- OR00412-21
 Rotated Arm- OR00410-21



OR00411



OR00412

Dial Mechanism helps allow precise control of inserted wires in small bone surgery

Hintermann Distractor

Closed Arm
 OR56438-1



Available in two sizes

To distract small joints in a linear direction in foot, hand and spine surgery



Outspreader Arm
 OR56438-1OS



New!
 To distract small joints in Episurf surgery

Calcaneal Spreader



RT418-01



Used for lateral column lengthening of the calcaneus

MIS Drill Guide Wire Passer



OR 8315-00

Very Useful for Wrist, Elbow, Foot-Ankle Reconstruction

Mippo Wire Passer



MP00001
 For large bones



Incision Aligner

New!



OR 1330
 Aligning the instrument with Incision by Extending one hook outward. The sliding end locks in place when tensioned.

Bone Mill

Table mounted with crank handle

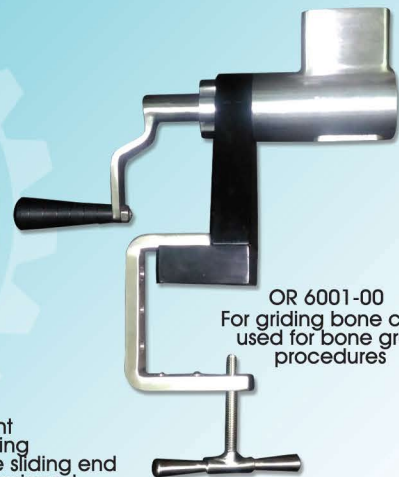

OR 6001-00
 For grinding bone chips used for bone graft procedures

Nagpur Retractor



4 mm pin
New!
 Idea by Dr. Anil Golhar
 For verticle retraction conventional charny retractor is used over acetabulum & greater trochanter to spread in other direction this retractor can be used.

Steinmann Pin Introducer
 Universal Chuck w/o Key
 Fully Stainless Steel



OR 5507-14
 14 cm/5 1/2" Length
 0.7 mm - 6 mm pins

JJ Raindrop K-wire Holder



OR00410
 A Chuckless K-wire holder for 0.5 to 2.5mm K-wires

Gelpi-Blade Retractor



New!
 OR40080
 Designed to help expose difficult to visualize areas at the end of incisions

Plate Holding Forceps



4.5 OR6045-20
 3.5 OR6035-20
 2.7 OR6027-16

Plate Holding Forceps with Screw Guide



4.5 OR60450
 3.5 OR60350
New!

Strayer Retractor



New!
 9.25"
 OR1869
 Blade Length: 8.9cm
 Blade Width: 1.5cm
 To retract the soleus muscle for exposure of gastrocnemius fascia

Charney Retractor



OR4006-10



OR4007-75
 OR4007-50



OR4006-75
 OR4006-60

With two pairs of blade

Offset Caliper

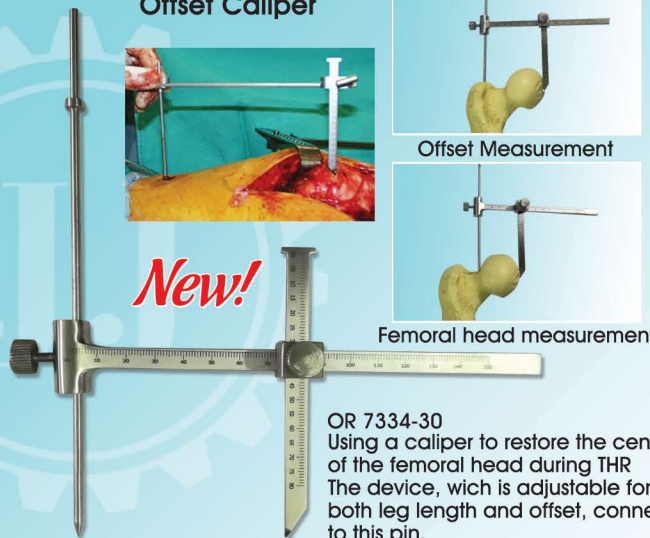

New!

OR 7334-30
 Using a caliper to restore the centre of the femoral head during THR
 The device, which is adjustable for both leg length and offset, connects to this pin.

Double Barrell Drill sleeve for Distal Femur

Save Radiation Slev

New!

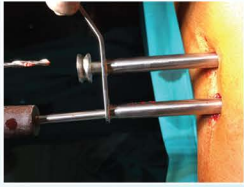

OR1110-01

Idea by
 Dr. Chandak, Nagpur

After fixing the first distal screw, You can fix the second screw without any "C" arm Exposure

PFN Entry Point Selector

New!



OR1050-01

Soft Tissue Bone Clamp

New!

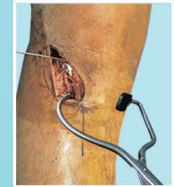

10" - OR5047-25
 8" - OR5047-20

It is used for reduction of bone fracture with radiolucent soft tissue attachment.

Micro Fracture Drill Sleeve

New!



OR1106-100

OR1102-25

45° Angled

Double Barrell Femoral Guide Sleeve

New!



OR1110-02

Idea By : Dr. Adithya Bothra
 Femoral Guide pin insertion,
 pelvic and acetabulum fixation,
 reverse diamond fixation.

RadioLucent Sleeve



Custom design

Ulna Nerve Protecting Sleeve

New!



OR1108-25

Idea By : Dr. Shah Miraj
 This k-Wire sleeve to protect
 ulna nerve while doing k-wire
 fixation for supra condyle
 humerus in children

Pediatric Lateral Condyle Clamp

New!



OR5042-15

'S' Wire Bender



OR00375

Bending on 120°

K-Wire Bender/Cutter



OR01801

Can bend and cutt
 K-Wires 1 to 1.6 mm



Bone Clamp with Drill Guide



HF502217

Chain Retractor

New!



Tendon Clamp with Slit

New!



- 1mm SHF 1.0
- 1.5mm SHF 1.5
- 2mm SHF 2.0
- 2.5mm SHF 2.5
- 3mm SHF 3.0
- 3.5mm SHF 3.5
- 4mm SHF 4.0
- 5mm SHF 5.0
- 6mm SHF 6.0
- 7mm SHF 7.0

For Cutting Tendon and Nerve Straightly

Scaphoid Lunate Clamps

New!



Reposition Forceps with K Wire Holder For Percutaneous Application

Reposition Forceps For Reduction of Hard to Reach Fractures

K Wire Inserter/Extractor

New!



For 1mm to 4.8mm Pins
 Adjust the Screw to Change the Size of K Wire

Guide Wire Holder



Quick holding and release of a Guidewire passing through the IM Canal. Also holding 1mm to 4mm K Wires

Asymmetric Webers Clamp

Straight, Curved, Reduction Forceps

New!



Make a 2.5mm hole in the shaft to accommodate the straight tip of the forceps curved tip will engage tip of Olecranon to allow placement of the plate while holding reduction. Also used medial malleolus fractures.

Femoral Tibial Spreader



Tibia Punch

New!



Designed to impact cancellous bone into the subchondral weight bearing region of the tibia

JJ Closed Reduction Forceps



OR00326

Idea-Dr. Harikumar, Kannur
 A radiolucent forceps for Closed reduction

Bone Awl 5"



Humrus Str. OR13614-02
 Humrus Cvd. OR13614-03
 Fore Arm Str. OR13614-00
 Fore Arm Cvd. OR13614-01
 Finger Str. OR13614-04
 Straight & Curved

Blade Retractors



15x5mm HF5215-05
 20x5mm HF5220-05 RT163
 15x8mm HF5215-08
 20x8mm HF5220-08
 Mini Langenbeck 5" Mini Sen muller 5"
 Available in any dimensions

Sharp Hook



OR00434

To Check Fracture and remove Ingrown tissue

Bone Rasp



OR6954

Bone Scoop



2mm OR723-02
 4mm OR723-04

Caroll Osteotome



2mm HF5291-02
 4mm HF5291-04
 6mm HF5291-06
 8mm HF5291-08
 9mm HF5291-09
 10mm HF5291-10
 12mm HF5291-12
 14mm HF5291-14
 16mm HF5291-16

Bone Graft Impactor



2mm OR723-02
 4mm OR723-04

Available in round and Rectangular shapes

Periosteal Elevator



3mmStr. HF7008-03
 5mmStr. HF7008-05
 3mmCvd. HF7018-03
 5mmCvd. HF7018-05

Straight & Curved
 3mm & 5mm

Tendon Aproximator



OR00408

Tendon Stripper 12" & 6"



HF5812-08
 HF5806-06

Available in two sizes

Tendon Seizing Forceps



HF5814-02



HF5810-15

Delicate

Tendon Interlacing Forceps



HF5254-15

Straight & Curved

Tendon Passer



HF5805-25

Adson 1x1



GN2781

New!

Idea by : Dr. Sudheer Warriar

JJ Collinear Reduction Clamp

New!

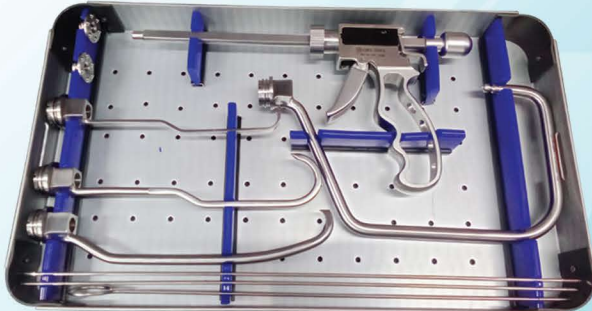

OR 1-500
 A Minimally invasive reduction



Surgical experience by
 Dr. Sreehari (MIMS Kannur)

Double - Ended Hohman bone leavers



6" 8" 10" 13"

Cannulated Bone Awl

New!



OR13112-00 OR13112

Suction tube and cautery holder



OR54330



OR00352

It allows accurate insertion of pins for internal fixation.

Distal Femur Distractor



OR4220-10

New!



OR4220-00

To distract distal femur from the proximal tibia.

Curette Osteotome

New!



OR6908

Easy removal of osteophytes and cartilage without having to switch tools

Femoral Cement Osteotome

New!



OR6907

To help trim away cement from around a femoral knee component

Charnley Ring Curette



T- handle
 OR 8430-37
 Double sided

37 cm/15" Length
 Serrated cutting edge

Intramedullary Irrigation Cannula

OR 1289-01



This cannula is very useful to give a through wash in side the intramedullary canal

Osteotomy Impactor



20mm
 OR1850

New!

To impact hinge area without breaking

Nose Pliers



Available in Narrow nose, flat nose, long jaw needle & dolphin nose

Inter Changeable instruments



Osteotomes, gouges impactors, curettes, Rasps with quick coupling handle

Cannulated Wire passers



Wire passers for patella forearm humerus Femour and Tibia

Wire - Passers



Used for Forearm, Humerus Femour & Tibiya

Guide Wire Sterilization Container



Idea-Dr. Francis Roy Flexible, Autoclavable available in 1mtr. and 1.25 mtr.

Syndesmosis Clamp



Idea By Dr. Wolfson, USA

Condyle Clamp



Design by-Dr. Vijay Bose, Chennai

Condyle Clamp with Sleeve



OR722-00

JJ Bone Curette with Suction



OR0043-04

Patella Holding Forceps



OR00363 OR00361 OR03610

Available with Ratchet lock Speed lock and Smart lock

Two pointed reduction Clamps



HF5042-23 HF5042-19 HF5042-14

Designed for Medical Malleolar / Bone Fragment

Bone Graft Holding Forceps



OR18502

Idea-Dr. Rajasekharan, Kovai Bone graft can be grasped & placed

JJ Stem Extractor



OR6909-25N

New!

The instrument is used to extract stem during hip revision surgery.

Cement Grasping Forceps



OR6903-25

OR6901-35

Cement Removal Instruments



Overall Length 13"

Femoral Head Bone Plug Cutter



OR00409

Taking bone from femoral head to plug femoral canal before cementing

Flexible Osteotomes

7" OR3807-20 OR3807-15 OR3807-10 OR3807-05
 9" OR3809-20 OR3809-15 OR3809-10 OR3809-05

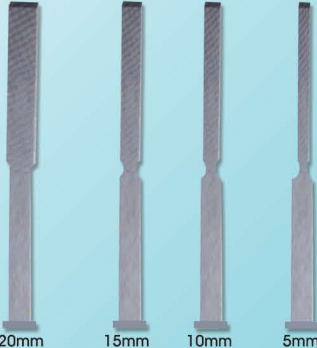

20mm

15mm

10mm

5mm

Sharp, Flexible blades are well suited for loosening implants from cement or bony in growth fixation

Ball Reamers



The extra long Ball Reamers may be used to ream cement layers as well as cement islands in the distal femoral cavity

Micro Forceps

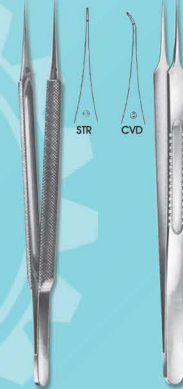

6" Round body plain & Toothed

6" Flat body plain & Toothed

Castro viejo Needle Holder Scissors



STR

MI610

MI520

CVD

MI611

MI521

6' Straight & Curved

Osteophytes Osteotome



OR7619-18

Mippo Tunnelers



20cm

25cm

30cm

MP00020

MP00025

MP00030

Wire Holder



TW203



10mm jaw
MI00419



20mm jaw
MI00326



MI405

Hand Reamers
Cannulated Reamer



Rigid Reamers



Wire Passer/Retrieval Forceps



Capsule Scissors



**Anteversion
 Osteotome**



Pelvic Impactor



**Femoral Head
 Extractor**



**Sub Trochanteric
 Reduction Clamp**



Pelvic Reduction Forceps

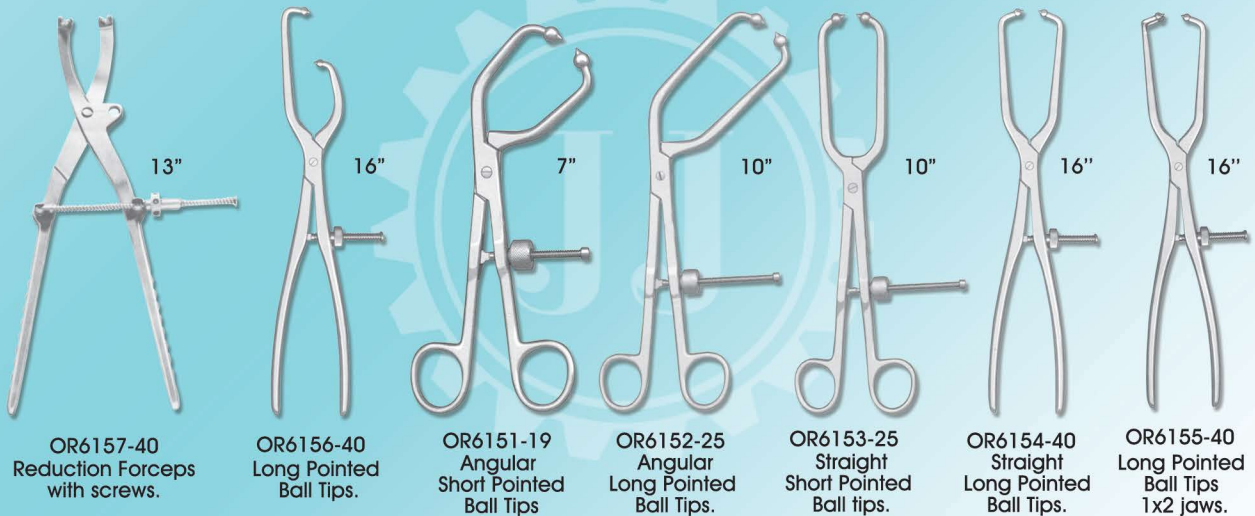

Kolbel Self Retaining Glenoid Retractor with Center Blade



SM 1063-20

Center blade
 Depth 6.4cm/2.5"

SM 1063-21

Blades - pair
 36mm x 36 mm
 SM 1063-36

Blades - pair
 36mm x 53 mm
 SM 1063-53

Subacromion Spreader



SM 6552-19

SM 6551-19

Used for massive tears and repair of a supraspinatus tear

Femoral Distractors



OR4005-00

RadioGraphic Ruler



OR 5008-00

Multi purpose pliers

With Strike Plate



Big OR00802
 Small OR00801 OR00802-00

Designed for bending and cutting of K-wires and plates. Available in two sizes

Plate Bending Plier



OR804

Distal Screw Aiming Device



OR04110

A Radiolucent device for distal locking aiming and drilling.

Plaster Cutting Guard

New!



Child Size
 OR1520-01

OR1520
 Designed to help protect the patient's skin when removing a plaster

JJ Ortho Suction Tube with Cleaning Brush



OR4230

Helps eliminate plugging due to bone, cement fragments blood clots etc...

Fracture Aligner



OR00327

Used to align the bone ends of a femur fracture.

New!



OR00328

For lesser Trochanter

Cement Removal



OR5245 OR5212 OR5211
 Double ended instrument designed for cement removal during arthroplasty surgery

Knee Self Retaining Retractors

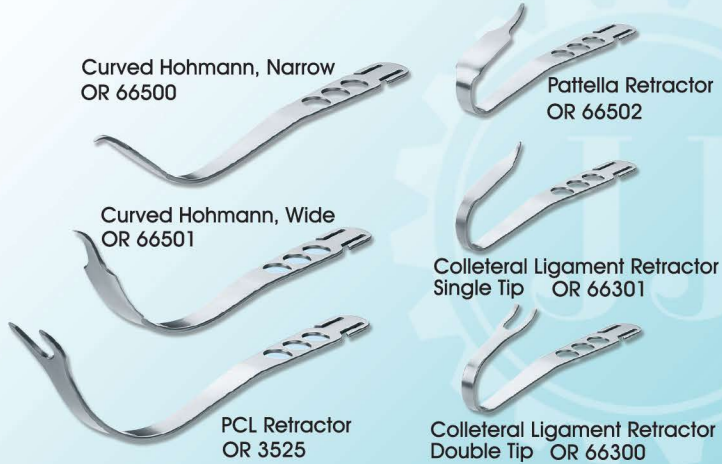

Z Knee Retractor



Helps create better access to the articulating surfaces

Collateral Ligament Retractor



Helps protect the lateral collateral ligament while exposing the proximal tibia

45° Knee Retractors



Designed for general use around the knee

5" Total Knee Retractor



Helps to protect the collateral ligaments and popliteal structures while providing excellent visualization within the knee joint

Honeycomb Drill Guide



Place the steinmann pin through the centre hole. If a slight adjustment is necessary, choose one of the alternate holes and slide the tissue protector off of the pin and back on to the new pin location with central hole aligned

Posterior Capsule and Sciatic Nerve Protection Retractors



Sits on the outer rim of the posterior/ inferior ischium to retract the posterior capsule for acetabular exposure and help to protect the sciatic nerve.

HIP Bone Levers

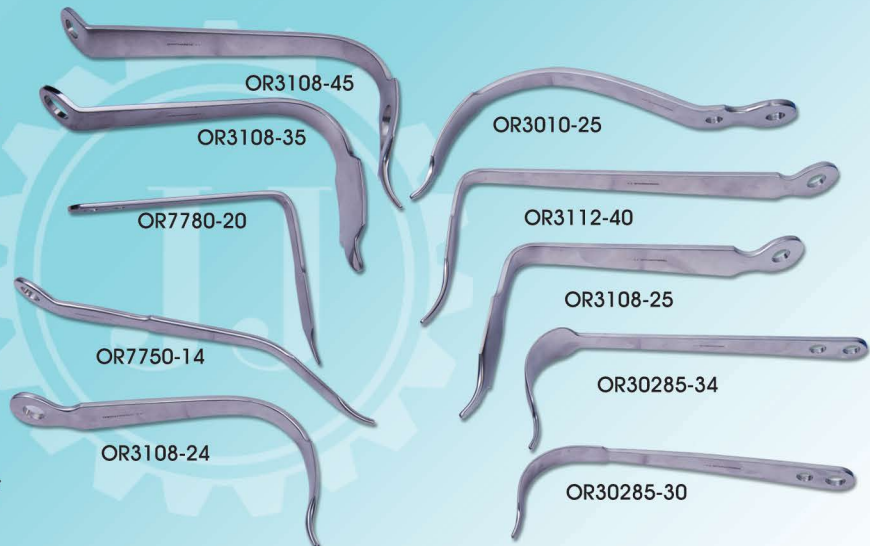

MIH Retractors



Overall Length 330mm
 Blade Width 25mm
 OR 2030



Overall Length 330mm
 Blade Width 32mm
 OR 2031



Overall Length 330mm
 Blade Width 40mm
 OR 2032



Deep Hohman
 Overall Length 330mm
 Blade Width 32mm
 OR 2033



Blunt Hohman
 Overall Length 330mm
 Blade Width 32mm
 OR 2034



Muller Hohman
 Overall Length 350mm
 Blade Width 25mm
 OR 2035

HIP Retractors



40° Angled
 Overall Length 280mm
 Blade Width 18mm
 OR 2451-28



Double Angled
 Overall Length 340mm
 Blade Width 41mm
 OR 2451-34



Blunt Retractor
 Overall Length 320mm
 Blade Width 24mm
 OR 2451-32



Blunt, Double Angled
 Overall Length 290mm
 Blade Width 24mm
 OR 2451-29



Bone lever After Ganz
 Overall Length 270mm
 Blade Width 24mm
 OR 2451-27



Pubis Retractor After Ganz
 Overall Length 260mm
 Blade Width 22mm
 OR 2451-26



Double Bend Hohmann
 Overall Length 280mm
 Blade Width 15mm
 OR 2451-28



Double Bend Hohmann
 Overall Length 310mm
 Blade Width 22mm
 OR 2451-31



Double Bend, Blunt Hohmann
 Overall Length 300mm
 Blade Width 20mm
 OR 2451-30



Bone Lever Amin Wide
 Overall Length 320mm
 Blade Width 32mm
 OR 2451-32



Bone Lever 65° V-Shaped Spike
 Overall Length 320mm
 Blade Width 30mm
 OR 2451-70



Trochant Bone Lever V-Shaped Long Spike
 Overall Length 330mm
 Blade Width 30mm
 OR 2451-33

HIP Retractors



Double Bend 2 Prongs Hohmann
 Overall Length 300mm
 Blade Width 17mm
 OR 2451-76



Double Bend, Wide, Blunt Hohmann
 Overall Length 310mm
 Blade Width 32mm, Tip Width 15mm
 OR 2451-78



Blunt Hohmann
 Overall Length 280mm
 Blade Width 32mm, Tip Width 15mm
 OR 2450-50



Neck Elevator, Muller
 Overall Length 380mm
 Blade Width 26mm
 OR 2451-90



90° Angled Deep Retractor
 Overall Length 210mm
 Blade Width 12mm
 OR 2452-21



Double Bend Hohmann Retractor
 Overall Length 303mm
 Blade Width 15mm
 OR 6210-02



Pelvis Retractor
 Overall Length 310mm
 Blade Width 22mm
 OR 1310-70



Cobra Retractor
 Overall Length 340mm
 Blade Width 36mm
 OR 1310-60



Cobra Retractor
 Overall Length 340mm
 Blade Width 30mm
 OR 1310-00



Bent Hohmann Retractor
 Overall Length 310mm
 Blade Width 22mm, Sharp Tip
 OR 1310-40



Bent Hohmann Retractor
 Overall Length 310mm
 Blade Width 22mm, Blunt Tip
 OR 1310-50



Bent Hohmann Retractor
 Overall Length 310mm
 Blade Width 22mm, Stub Tip
 OR 1310-10

Bent Hohmann Retractor 90°
 Overall Length 250mm
 Blade Width 19mm
 OR 3195-19



Bent Hohmann Retractor 90°
 Overall Length 185mm
 Blade Width 19mm
 OR 3108-19



AVA Retractor
 Overall Length 285mm
 Blade Width 22mm, Blunt Tip
 OR 4540-01



AVA Retractor
 Overall Length 285mm
 Blade Width 22mm
 OR 4540-02



Femoral Neck Elevator
 Overall Length 388mm
 Blade Width 32mm, Cup Model
 OR 1309-40



Femoral Neck Elevator
 Overall Length 325mm
 Blade Width 25mm
 OR 1309-50



Femoral Neck Elevator
 Overall Length 332mm
 Blade Width 25mm
 OR 1309-70

HIP Retractors with Grip Handle



HIP Skid
 Overall Length 300mm
 Blade Width 29mm
 OR 1309-20



Cobra Retractor
 Overall Length 340mm
 Blade Width 30mm
 OR 1310-10



Pelvis Retractor
 Overall Length 310mm
 Blade Width 22mm
 OR 1310-71



Double Bend Hohmann Retractor
 Overall Length 390mm
 Blade Width 15mm
 OR 1308-51



Bent Hohmann Retractor 90°
 Overall Length 340mm
 Blade Width 19mm
 OR 1308-71



AVA Retractor
 Overall Length 370mm
 Blade Width 22mm, Blunt Tip
 OR 1309-11

New!

Radiolucent Bone Levers



Cobra Retractor
 OR 1310-30R



Cobra Retractor **Shallow Bone Lever**
 OR 1310-35R OR 7755-25R

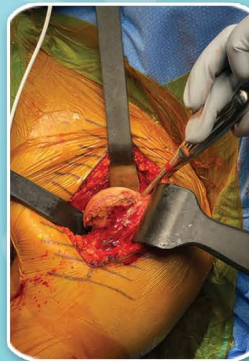

Succesfull Feedback Reference

- Dr. Babu Joseph**
(Renai Medicity, Kochi, 9847165295)
- Dr. Karthik Shukla**
(Ahemadabad, 9825296189)
- Dr. Dr. Rajeev Raj Choudhari**
(Surat, 9824057579)
- Dr. Dr. Swarnendu Samanta**
(Kolkatha, 9830083031)

Radiolucent Bone Levers



Modified Hohmann
 OR 4540-20R



22mm Standard Hohmann
 OR 3018-22R



30mm Standard Hohmann
 OR 3018-30R



Humeral Retractor
 SM 0592-21R



Browne Deltoid Retractor
 SM 0500-21R

New!

Radiolucent Retractors

30 x 10



OR2530-10R

30 x 30



OR2530-30R

50 x 30



OR2550-30R

New!

CASPAR MICRO LUMBAR DISCECTOMY RETRACTOR

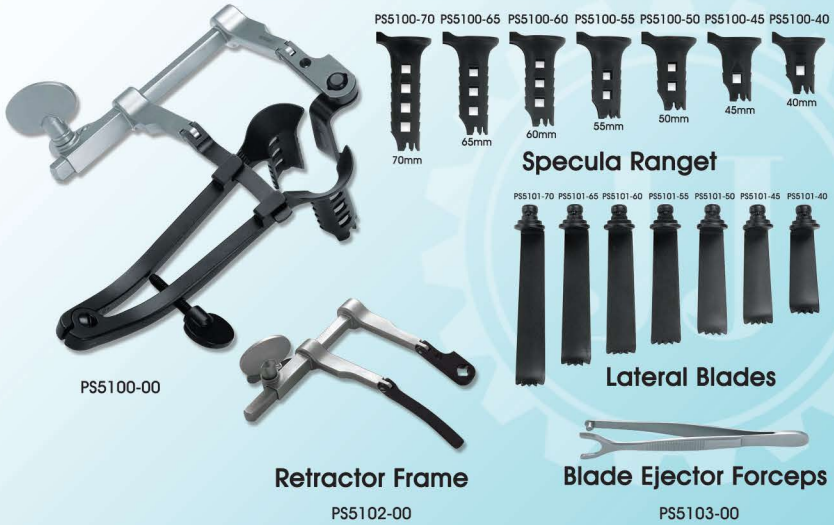

Micro Discectomy Retractor PS5200-00



Caspar Vertebral Body Distraction Set

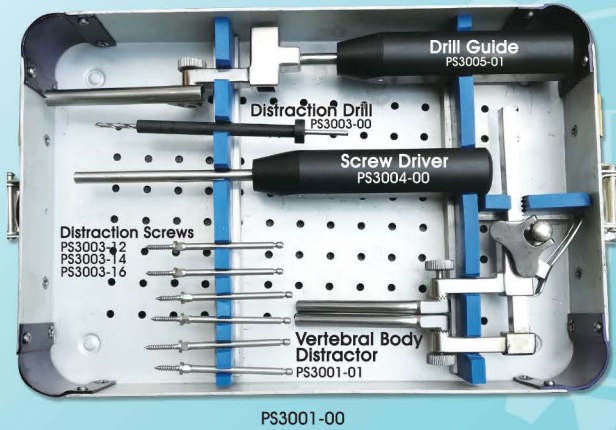

Super -Slide Laminectomy Retractor

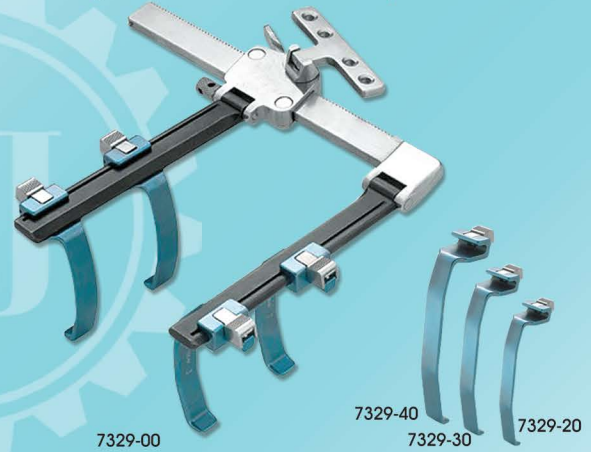

Laminectomy Retractor



Finochitto retractor with hinged arms and detachable blades.

Cervical Retractor set

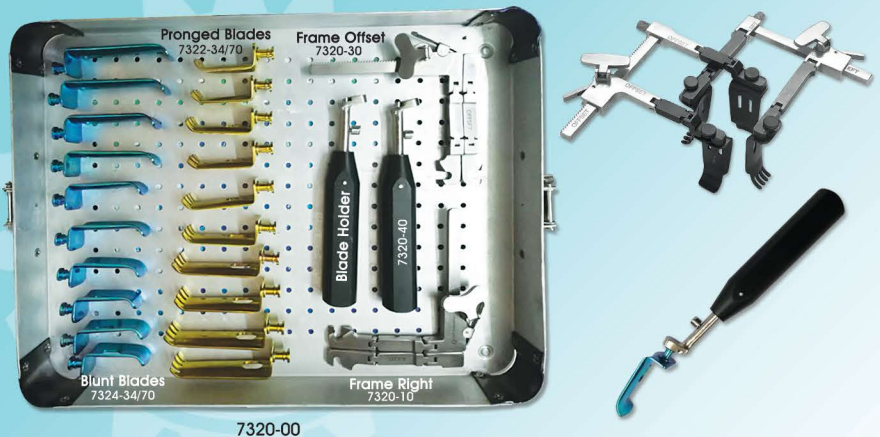

Cobbs Periosteal Elevator



12" Long, sizes 10 mm
 15mm, 20mm, 25mm

Bone Marrow Aspiration Needles

13G 11G



OR131-02 OR131-03
 Needles with depth stop and trocar. Available in two sizes

Bone Biopsy Needles with Trocar and Ejector



OR130-03 OR130-08
 Available in two sizes 3mm and 8 mm

Bone Graft Funnel



5 mm OR00045
 8 mm OR00048

5 & 8 MM bore funnel with piston can be used to pack bone graft in hard to reach places in a minimally invasive method.

Kerrison Laminectomy Rongeurs



Thin Foot Plate
 5mm PS2608T-05
 4mm PS2608T-04
 3mm PS2608T-03
 2mm PS2608T-02
 1mm PS2608T-01



Regular
 5mm PS2608R-05
 4mm PS2608R-04
 3mm PS2608R-03
 2mm PS2608R-02
 1mm PS2608R-01

Bayonet Cervical Curette



cup size

PS7418-40	0000	PS7418-40CL
PS7418-30	000	PS7418-30CL
PS7418-20	00	PS7418-20CL
PS7418-10	0	PS7418-10CL

8 1/2"

9 1/2"

Foramenotomy Punch



Ferris-smith Kerrison Punch



Black Plasma Coated, thin Foot Plate, detachable with ejector

Long Anterior Kerrison Punch



PSKF 4002
 PSKF 4003
 PSKF 4004
 PSKF 4005

Intervertebral Disc Rongeur



Straight

PS1502-18
 PS1503-18
 PS1504-18
 PS1505-18

Kerrison Punch Down



PSKD 9081
 PSKD 9082
 PSKD 9083
 PSKD 9084

Upward

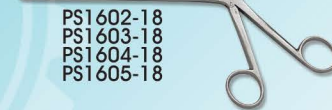

PS1602-18
 PS1603-18
 PS1604-18
 PS1605-18

Intervertebral Disc Rongeur Black



PSKD 9081B
 PSKD 9082B
 PSKD 9083B
 PSKD 9084B

Downward



PS1702-18
 PS1703-18
 PS1704-18
 PS1705-18

JJ Bone Clamps with Drill Guide



- OR1890-02 9.25"
Large- 10mm Drill Guide
- OR1890-01 6"
Small- 8mm Drill Guide
- OR1890-00 4"
Extra Small- 6mm Drill Guide

Designed for the placement of bone clamp where it can best stabilize bone fragments. Drill guide allows screw placement through top of clamp.

JJ Modified Meniscal Clamp



- OR1883
Length: 7" (17.8 cm)
Jaw length: 1.5" (3.8 cm)

Designed to help facilitate grasping the posterior portion of meniscus. Improved bite when tension is placed on the meniscus and also used to help remove fat pad and suprapatellar bursa.



JJ Femoral Neck Cutting Guide

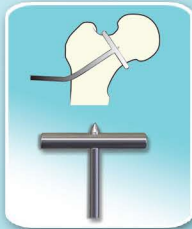

- OR4590
Overall Length: 8.25" (21 cm)
Shaft angle at end: 30°

Designed to help determine the femoral neck osteotomy location during the anterior approach for THA.

JJ Fracture Distractor

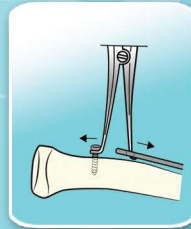

- OR1882
Overall length: 17.8 cm

Designed for providing opposing leverage to help bring the fibula (or any bone) back out to its proper length after it has been shortened by a fracture.

JJ Hip Length Gauge



- OR1327-00

Helps to determine the leg length and hip offset in total hip arthroplasty, including minimally invasive techniques.

JJ Malleable Bone Tamps



- OR5296
Overall length: 37 cm
Ø 13 mm
- OR5296-01
Overall length: 25 cm
Ø 10 mm

The large tamp helps to elevate a depressed tibial plateau fracture. The small tamp helps to elevate a depressed tibial plateau and smaller tibial plateau fractures.

JJ Modified Pin Inserter



- OR3016
K-wires upto: 1.4 mm
Tube Length: 47 mm
Overall Length: 11.4 cm
Handle Length: 9.8 cm

Designed to aim and control the placement of flexible k-wires when they contact hard cortical bone, while helping to protect neurovascular structures from the spinning wire.

JJ Tibia Punch



- OR5140
Overall Length : 17.8 cm

Designed to impact cancellous bone in the subchondral weight bearing region of tibia. This helps to improve mechanical interlock in the cancellous bone/cement interface.

JJ Tibial Plateau Elevators



OR5298 OR5297
 Finish Starter
 Ø 10.4 mm Ø 4.7 mm
 Overall Length
 27.9 cm
 Idea By : Dr. Chandak,
 Nagpur

Designed to help with indirect reduction of a depressed tibial plateau fracture, and can be used with arthroscopic visualization and percutaneous fixation.

JJ Osteophyte Grasper



OR1776
 Overall Length: 11.20" (28.5 cm)
 Shaft Length: 7.28" (18.5 cm)
 Shaft Width : 7 mm
 Jaw Width at End: 4 mm
 Toothed Jaw Length: 14 mm

Useful in helping to remove posterior osteophytes in knee surgery, and helps to remove the labrum and soft tissues in anterior total hip surgery.

JJ Patella Double Scalpel Handle



GN138-06
 Length: 5.75" (14.6 cm)
 #3 handle size

The offset of blade is 10mm. Harvests tendon graft from the patella and tibial tubercle including the patellar tendon.

JJ Pin Clamp



OR1760-01
 Overall Length: 6"
 1.8 mm cannula

Designed to allow accurate insertion of pins for internal fixation.

JJ Ruler With Right Angle Handle



OR1450
 Handle Length: 4.25" (10.8 cm)
 Ruler Dimensions: 2.5 x .5"

90° angle handle. Designed to measure the femoral head/neck length.

JJ Ruler with 45° Angle Handle



OR1430
 Handle Length: 5" (12.7 cm)
 Ruler Dimensions: 2.5" x .5"

45° angle handle. Designed to measure distances in small deep incisions.

JJ Vernier Caliper



OR7338-00
 Length 22.5 cm
 Measuring Range 15 cm

This instrument is used for measuring the disc space and diameter of the femoral head.

JJ Small Bone Tamp with Oblique K-wire Hole



OR5294
 Wire hole 1.1 mm k-wire
 Overall length: 19.1 cm
 Shaft diameter: 6.3 mm
 End diameter: 2.5 mm

OR5294-01
 Wire hole 1.6 mm k-wire
 Overall length : 19.1 cm
 Shaft diameter : 6.3 mm
 End diameter : 2.5 mm

This design helps in the concurrent reduction of a fracture and placement of a wire into the fracture site. It is particularly helpful when the surgical exposure is small and tight, the fracture fragments are small, and the reduction is demanding.

JJ Radiolucent Retractors



OR22550-R2K
 length 21.5cm
 Ø3.2 mm K-wires

OR25230-R
 length 24 cm

OR25210-R1K
 length 20cm
 Ø 3.2 mm K wire

OR22550-R2K: Designed to retract the iliac vessels.

OR25230-R: Acetabular Rim Retractor. To be placed near ilio-pubic eminence.

OR25210-R1K: To be placed near pubic tubercle.

JJ 90° Bone Hook



OR5940-S Sharp Tip
 OR5940-B Blunt Tip

Designed to ergonomically help the surgical assistant elevate the proximal femur during TKA.

JJ Femur/ Tibia Fracture Distractor



OR1809
 Overall Length : 10.5" (26.7cm)
 Overall Width : 7.25" (18.4cm)
 For Pins upto : 0.25" (6.4mm)

JJ Femur/ Tibia Fracture Distractor is used with self centering bone clamps for diaphyseal fractures and 6mm Schanz pins to distract intra-articular fractures for reduction and fixation.

JJ Anterior Hip Referencing Rod Assembly



OR2674-00 - Full assembly
 Overall Length: 27.75"
 Rod Diameter: 0.25"

OR2674-A - Top assembly
 Overall Length: 16.75"
 Rod Diameter: 0.25"

OR2674-B - Bottom assembly
 Overall Length: 10.5"
 Rod Diameter: 0.25"

It helps to determine implant fit, position, alignment and recreation of leg length and offset using the contralateral hip for reference.

JJ Goniometer with Ruler



OR2029

JJ Goniometer is used to measure an angle or to permit rotation of a joint to a definite position. Ruler attachment helps in precise measurement along the area.

JJ Bayonet Mani Clamp



Radius
 Right : ORB00347R
 Left : ORB00347L
 Humerus
 Right : ORB00349R
 Left : ORB00349L

An updated bayonet design of JJ Mani clamp.

JJ Radiolucent Awl



OR8030-01

JJ Radiolucent Owl is used to locate the holes in interlocking nails.

JJ Amputation Shield



OR8898

This instrument is designed to use as a shield for protection during amputation procedures.

JJ Adjustable Knee Positioner

OR2770-00

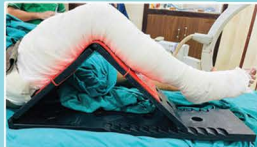

Succesfull Feedback
 By
 Dr. Hemant Maurya
 Shikha Hospital, Allahabad



Height:16" Height:14" Height:11"

Available in Fixed Model

JJ Adjustable Knee Positioner with Leg Support

OR2770-LS



New!

JJ Adjustable Knee Positioner is used for proccures around the knee. The adjustable design helps in positioning at different heights and angles.

JJ Adjustable Knee Positioner with leg support for additional support for the foot.

JJ Acetabular Knife



OR11122
 Length : 10"

JJ Universal Tibia/ patella clamp

OR3685
 Length : 10"



The design helps in removal of tibia wedge and also helps in everting patella.

Malanski Retractor



OR3110-30
 Overall Length: 9"

Whelan Retractor



OR7116
 Blade Depth: 6"
 Overall Length: 14.5"

JJ Canal Opener



OR3006-01
 Overall length : 60cm

JJ PFN Aimer

OR5008



Designed by
 Dr. Harjot Singh Gurudatta

Contributions by
 Dr. RM Chandak &
 Dr. Abhishek Tiwari

This device is a PFN Aimer which helps in determining the cranial and caudal placement of two screws in two screw PFN system. This is a radiolucent device and will avoid the multiple k wire insertion and multiple adjustments while insertion of a PFN.

JJ Ratchet Bone Clamp

OR6180-23R

Overall length : 23.5cm
 Jaw Opens to : 8 cm



JJ Ratchet Bone Clamp is designed for quick tightening and release around the bone.

T Handle Ruler



OR443-040
 20mm

To make measurements inside the surgical site to assist in implanting a prosthetic femoral hip into the intramedullary canal of the natural femur.

JJ Chain Retractor



RT6828-00 Complete Set
 Four Retracting Blades
 Blade Holder
 Mounting Frame

JJ Chain Retractors is a self retaining table mounted retractor used for General and Gynaecology procedures. The set includes four retracting blades and a blade holder along with chains which helps in effective retracting at different heights.

JJ Thomson Retractor

TRT6969



JJ Thomson Retractor is designed to provide access and exposure for various procedures such as all Spine Surgeries, Transplant Surgeries, Abdominal General Surgery and Abdominal Vascular Surgery.

Last Screw Retractor

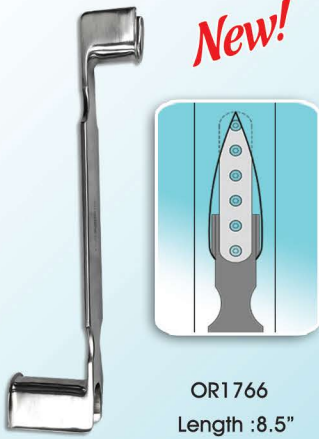

It is used to widen the incision to insert the last screw.

Cobbs Elevator with Suction



It is used to provide better exposure during spine, hip and trauma cases with a suction provision.

Dissectors with Suction



Dissectors used for elevating with a suction provision.

JJ Weitlaner Retractors with Radiolucent Tip



Weitlaner Retractor with Radiolucent tips used for retraction of tissues and muscles.

JJ Gelpi Retractors with Radiolucent Tip

Gelpi Retractor



Gelpi Retractor with Radiolucent tips used for retraction of tissues and muscles.

Gelpi Retractor with Flat Tip



Gelpi with Radiolucent Flat tips used to provide better holding grip during retraction.

Titanium Needle Holder



Needle Holder made of Grade 5 Light weighted Titanium.

Titanium Weitlaner Retractor



Weitlaner Retractor made of Grade 5 Light weighted Titanium.

Titanium Vascular Clamps



Vascular Clamps made of Grade 5 Light weighted Titanium.

JJ Interchangeable Impactor Set



- Round Head 09mm
- Round Head 09mm
- Square Head 10 x 10mm
- Rectangle Head 12x 08mm
- Oval Head 13 x 08mm

Length : 9"

OR11122

New!

The Special JJ Interchangeable impactors Set with five different impactor heads.

JJ Humeral Head Holding Forceps Wire Guide



New!
Length : 9"

JJ Humeral head holding forceps with three 3.2mm wire hole on each side.

JJ Glen Graft

OR401-531



New!

In a Glenoid shoulder recon, when an offset or angled glenoid is discovered, the surgeon may need to place a graft to "level" the surface for the implant. The instrument we are creating is a graft holding jig. The angles of K wire placement are key as well as the centering jig for the implant tap piece.

JJ Radiolucent Finger Positioner



New!

OR1134
Overall Length : 7"
Handle Width : 4"
Blade Width : 40mm



The fully radiolucent JJ Finger Positioner is used to provide the required positioning of finger during hand surgical procedures.

JJ Radiolucent Murphy Skid



New!

OR0589-23R
Overall Length 11"

The fully radiolucent JJ Murphy Skid used to retract muscle and tissue.

Flexible Reamer



OR69020

New!

The flexible reamer system is intended to clear the medullary canal of bone marrow and debris and to effectively enlarge the medullary canal of long bones for the acceptance of an intramedullary nail.

MCL Retractor



New!

Length : 8.625"
OR7109

It is used for retracting the femur and protect the MCL.

JJ Carpel Tunnelor Guide

HF5888-03

New!



JJ Carpel Tunnelor with tissue protector and knife.

Versatile Small Bone Spreader



New!

OR1829

Overall Length : 5"

Blade Depth : 28mm

Blade Tapers from 10mm to 6mm

The small tapered blade helps in retracting small tight bone areas.

JJ Shoulder Retractor Frame and Blade Set

OR4696-00



New!

Blade Size 41mm x 55mm



Blade Size 43mm x 45mm



Blade Size 32mm x 35mm



228mm x 203mm

JJ Distal Radius Mini Frame and Blade Set

OR1578-00



New!

Blade Size 15mm x 15mm



Blade Size 15mm x 25mm



Blade Size 15mm x 35mm



Frame 70mm x 60mm

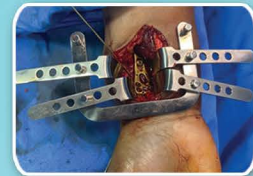

JJ Radiolucent Distal Radius Mini Frame and Blade Set

OR1578-00R



New!

Blade Size 15mm x 15mm



Blade Size 15mm x 25mm



Blade Size 15mm x 35mm



Frame 70mm x 60mm



JJ Needle Nosed Vise Grip Parallel Plier with Soft Lock



OR2008-25
 Length :9"

New!

JJ special needle nosed vise grip plier with parallel opening and soft lock.

Laterjet Instruments

Coracoid Drill Guide



New!

OR7000-17

The Coracoid Drill Guide is used to shape and size the coracoid and make two drill holes in the coracoid.

Laterjet Screw Insertion Guide



OR107-12
 6mm Offset

New!

It is used for laterjet screw insertion during glenoid surgery.

Shoulder Retractor Set *New!*

Dual Point Glenoid Retractor

SM861-104



10"
 20mm

Two Prong Forked Retractor

OR5842

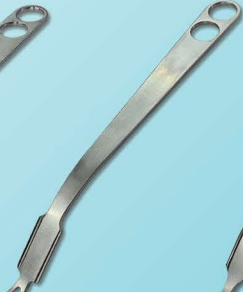

10.5"
 20mm

Hohmann Retractor

OR3019-20



10.25"
 20mm

Wolfe Retractor

OR861-108



11"



6 Teeth

Bhattman Retractor

OR861-004



9"

Deltoid Retractor

SM1001-50



Length 10.5"
 Depth 2"

JJ Nathanson Retractor

RT7788



New!

Small

Medium

Large

Extra Large

It is used for retracting the liver during laparoscopic surgery.

JJ Broken Screw Removal Instruments



OR1329-00

New!

Extended broken screw removal set with TiN coated attachments.

Toronto Mallet



New!

OR3900-00A

Toronto Mallet made of delrin for soft impacting.

Bone Screw Ruler Gauge



New!

OR443-752

It is used to measure screw length at table top and also to measure k wire sizes.

K Wire Sizer



New!

KSW001

It is used to measure various k wire sizes from 0.7mm to 3.0mm.

Tibial Plateau Forceps



New!



OR5299

Tibial Plateau forceps is used for grasping tibial bone fragment.

JJ White Line Marker

Idea By
 Dr. Ayman Ahmed Hilaly
 Khoula Hospital, Oman

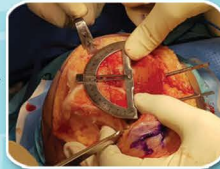

OR2029-00

New!

The modified design of goniometer which helps to intraoperatively measure the angle between white side line and posterior condylar line.

Femur Tibia Spreader with Soft Pad



New!

OR2020-00R

Femur tibia spreader with soft pad attachment is used to separate femur and tibia.

Scarf Bone Holding Forceps



New!



OR6150-17
 Length : 7"

It is used for holding small bone during surgeries.

Kolbel Retractor with Radiolucent Blades



New!

SM1062-23R
 Blade depth
 53mm

Kolbel Retractors with radiolucent blades are used to retract tissue during shoulder surgery.

Revision Component Remover



New!

Standard
 OR5120-01

Offset
 OR5120-02

The instrument is specially designed for the extraction of components during revision surgery.

Carpel Tunnelor

New!



Bayonet Shaped

HF5889-00

It is used as tunnelor for metacarpel.

Malleable Shoulder Retractor

New!



Length : 15.5"

Deep
22mm Width
OR4537-01

Shallow
22mm Width
OR4537-02

Wide
30mm Width
OR4537-03

Malleable Shoulder retractors are used to provide better exposure during surgery.

JJ Muller Compression Device

New!



OR03490

It achieves interfragmetary compression by tightening a tensioner that is temporarily anchored to the bone and the plate.

V Retractor

OR4851

New!



Overall Length : 9"

Depth 7cm

It is useful in providing deep access to the glenoid rim during shoulder surgery.

Elbow Retractor

New!

SM4697

Length: 7"



Designed to retract the anterior capsule in the elbow for better exposure.

Deltoid Elevator

OR5081

New!



It is used for lifting the deltoid for better exposure of the Subacromial Space.

Radiolucent Shoulder Slide

OR6879R

Length: 11"



New!

Radiolucent Shoulder Slide is used to protect the prosthetic bearing surfaces during shoulder arthroplasty.

New!

JJ Tension Retractor

OR1586



Width x Depth

30mm x 75mm

30mm x 50mm

30mm x 25mm

Length : 9.5"

JJ Tension retractor with different blades provides enhanced exposure during surgical procedures.

JJ Lonstar Retractor

New!



LS302-113

LS302-220

Hook attachments

Rake Hooks

Sharp Hooks

Blunt Hooks



Biocompatible, Reusable, Radiolucent & Light weight.

Instruments with Spring and Ring Handle

Forceps
SRF-13A



Idea By
Dr. Nabarun Saha
Berhampore

Scissors
SRS-13A



JJ Interchangeable Screwdriver Set

New!



Set with 2 Quick Coupling Handles and 14 Screwdriver Heads

ORD7017-10

- Quick Coupling Handle**
- Straight Model
- T handle Cannu. Model

Screw Driver Heads

- Hex 2.5
- Hex 2.7
- Hex 3.5
- Hex 3.5 Cannu.
- Hex 4.5
- Hex 4.5 Cannu.
- Hex 6
- Star T5
- Star T6
- Star T8
- Star T10
- Star T15
- Star T25
- Cruciform 2

JJ Radiolucent Light Weight Cervical Retractor



New!
RT1579-01R

- Blades Depth**
40mm
50mm
60mm
70mm

JJ Parallel Drill Sleeve

Adjustable



Available in
65mm OR1021-65
75mm OR1021-75

New!

Parallel Drill Sleeve with adjustable sleeve position.

JJ Double Ended Radiolucent Awl

With 4 Interchangeable Pins

OR8030-02



New!

- 2mm
- 3mm
- 4.5mm
- 5.5mm

JJ Radiolucent double ended awl with four interchangeable pins is used to locate the holes in interlocking nails.

JJ Fossa Finder with Handle

OR1000



New!

Used to locate the piriformis fossa or greater trochanter for guide wire insertion.

JJ Oval Retractor

Radiolucent



New!

HF1580-00R
Frame & 5 Pairs of Retractor Hooks
The light weight retractor set is used for hand surgeries

JJ Strong Extractor Forceps with T Handle

3.5
ORD00329-35T

4.5
ORD00329-45T

New!



Strong extractor forceps for removal of screws.

JJ Chuck with Delrin T Handle

OR5505-014

With Key

New!



Chuck with key for holding k wires.

Bone Holding Forceps Ikkufa



New!



HF5055-20
Long Ratchet

It is used in Shoulder Surgery

JJ Femoral Component Trunion Clamp

OR6911-23



Bayonet
9"



New!

JJ Acetabular Screw Holding Forceps

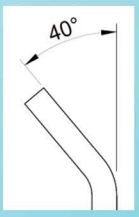

Angled Up



New!

OR1490-25

JJ Reduction Clamp with Drill Sleeve

New!



8"
OR5042R-21S
9"
OR5042R-23S

Long Ratchet

JJ Light Weight Bone Levers with Handle

Superior Femoral Neck Elevator

OR1440-07



New!

Various bone levers available with this design.

Glenoid Exposure Spreader

Left- SM6551-20L
Right - SM6551-20R



New!

Used in shoulder surgery for exposure of glenoid.

JJ Bone & Plate Holding clamp with Swivel Head

New!



Swivel Head
3.5
OR6035-10
4.5
OR6045-10

Bone and Plate Holding forceps with tiltable Swivel head for better holding.

JJ Parallel Tibial Spreader with Soft Lock

Parallel Spread upto 25mm

New!



OR2025-14S

Used for Parallel Spreading of Femur Tibia

Femur Tibial Spreader with Silicon Pad



New!



OR2024-17SP

Femur tibia spreader with silicon pad attachment is used to separate femur and tibia.

Acetabular Lining Impactor

New!



PS6918-21

JJ 'One Stop Store' for all Surgical Instruments

Orthopaedic Surgery

International Instruments
 Designers & Manufacturers of Surgical Instruments

Orthopaedic Surgery

USFDA, CE & ISO REGD.

Kinfra Park P.O., Koratty, Thrissur District, Kerala, India 680309 | +91 480 2735959, 2735858, +91 94970 77555
 sales@myjonline.com | myjonline@yahoo.com
 www.myjonline.com
 INDIA+USA+OMAN+UAE

Spine Surgery

International Instruments
 Designers & Manufacturers of Surgical Instruments

Spine Surgery

USFDA, CE & ISO REGD.

Kinfra Park P.O., Koratty, Thrissur District, Kerala, India 680309 | +91 480 2735959, 2735858, +91 94970 77555
 sales@myjonline.com | myjonline@yahoo.com
 www.myjonline.com
 INDIA+USA+OMAN+UAE

Cardiovascular Surgery

International Instruments
 Designers & Manufacturers of Surgical Instruments

Cardiovascular Surgery

USFDA, CE & ISO REGD.

Kinfra Park P.O., Koratty, Thrissur District, Kerala, India 680309 | +91 480 2735959, 2735858, +91 94970 77555
 sales@myjonline.com | myjonline@yahoo.com
 www.myjonline.com
 INDIA+USA+OMAN+UAE

General Surgery

International Instruments
 Designers & Manufacturers of Surgical Instruments

General Instruments

USFDA, CE & ISO REGD.

Kinfra Park P.O., Koratty, Thrissur District, Kerala, India 680309 | +91 480 2735959, 2735858, +91 94970 77555
 sales@myjonline.com | myjonline@yahoo.com
 www.myjonline.com
 INDIA+USA+OMAN+UAE

Orthopaedic | Spine | Hand & Micro
 Plastic | Maxillofacial | Laparoscopy
 General | Gynec & Obstetrics | Uro
 E.N.T | Cardiovascular | Thoracic | Neuro

JJ 'One Stop Store' for all Surgical Instruments

Plastic Surgery

INTERNATIONAL INSTRUMENTS

Plastic Surgery

JJ
always innovative

USFDA, CE & ISO REGD.

Neuro Surgery

JJ International Instruments
 Designers & Manufacturers of Surgical Instruments

Neuro Surgery

USFDA, CE & ISO REGD.

Kinfra Park P.O., Koratty, Thrissur District, Kerala, India 680309 | +91 480 2735959, 2735858, +91 94970 77555
 sales@myjjonline.com | myjjonline@yahoo.com
 www.myjjonline.com
 INDIA • USA • OMAN • UAE

Laparoscopy Surgery

JJ International Instruments
 Designers & Manufacturers of Surgical Instruments

Laparoscopy Instruments

Orthopaedic | Spine | Hand & Micro
 Plastic | Maxillofacial | Laparoscopy
 General | Gynec & Obstetrics | Uro
 E.N.T | Cardiovascular | Thoracic | Neuro

USFDA, CE & ISO REGD.

Kinfra Park P.O., Koratty, Thrissur District, Kerala, India 680309 | +91 480 2735959, 2735858, +91 94970 77555
 sales@myjjonline.com | myjjonline@yahoo.com
 www.myjjonline.com
 INDIA • USA • OMAN • UAE

Gynec Surgery

JJ International Instruments
 Designers & Manufacturers of Surgical Instruments

Gynec Surgery Instruments

Orthopaedic | Spine | Hand & Micro
 Plastic | Maxillofacial | Laparoscopy
 General | Gynec & Obstetrics | Uro
 E.N.T | Cardiovascular | Thoracic | Neuro

USFDA, CE & ISO REGD.

Kinfra Park P.O., Koratty, Thrissur District, Kerala, India 680309 | +91 480 2735959, 2735858, +91 94970 77555
 sales@myjjonline.com | myjjonline@yahoo.com
 www.myjjonline.com
 INDIA • USA • OMAN • UAE



International Instruments

Designers & Manufacturers of Surgical Instruments

US FDA, CE & ISO REGD.

ABOUT US

JJ International Instruments - A leader in designing and manufacturing of high quality stainless steel surgical instruments in India. With a vast experience of 46 years in the industry, JJ provides unmatched service and unbeaten quality to the worldwide market. Corporate office and manufacturing unit with state of art facilities is located in south Indian state, Kerala - The renowned 'God's Own Country'.

CONTINUES SUCCESS...!

JJ is now worldwide since exhibited in AAOS 2013 with tremendous response from both domestic and international surgeons. JJ now participates several tradeshows in USA and more than 30 tradeshows all over India yearly.

" International Quality @ Indian Price "

CE Reg No. 2P191227.IIWT46
ISO Reg No. MD-QMS/91/R/I/2643
US FDA Reg No. 3010077069
CDSCO Reg No:
Intern-Thris-KL/M/MD/010840

INDIA • USA • OMAN • UAE

JJ design & manufacture complete Surgical Instruments for - General Orthopaedic, Spine, Hand & Micro Surgery, Gynec & Obstetrics, Uro, E.N.T, Neuro, Thoracic & Cardiovascular, Plastic, General surgery.

Features and Benefits

- Genuine 'JJ' Brand
- Custom made instruments
- Made out of German Stainless Steel- SS 410 & SS 420
- Follows International Passivation standard - ASTM 967
- International hardness of product - 45 HRC & 50 HRC
- Universal Specifications & Quality
- 5 years replacement warranty against manufacturing defect
- Absolute Competitive price
- JJ welcomes innovative ideas and designs
- Gift packs on attractive terms

JJ's repairing & refurbishing program:

- Repairing & refurbishing of surgical instruments of any brand
- Reduce purchase budget drastically
- Annual Maintenance Contract (AMC)
- Round the clock service center
- Replace damaged instrument with new until rectification

JJ's Mobile Trade Expo

- Introducing mobile sales and service all over India
- Specially designed instruments on display
- Easy to select, exchange and experience
- Get technical advice from the experts
- Contact us for mobile trade expo schedules

www.myjjonline.com

sales@myjjonline.com, myjjonline@yahoo.com

